

MADISON PIKE (KY 17) INTERSECTION IMPROVEMENT STUDY

KENTON COUNTY, KENTUCKY



Prepared For:
Northern Kentucky Area Planning Commission
Kentucky Transportation Cabinet
City of Fort Wright
City of Covington

Prepared By:
DLZ Kentucky, Inc.
CDS Associates, Inc.

September 2006



ACKNOWLEDGEMENTS

Contributing Organizations

City of Fort Wright
Kentucky Transportation Cabinet (KYTC) Central Office
Kentucky Transportation Cabinet – District 6
Northern Kentucky Area Planning Commission (NKAPC)
Ohio Kentucky Indiana Regional Council of Governments (OKI)
Transit Authority of Northern Kentucky (TANK)
Kentucky Transportation Center – UK (KTC – UK)
City of Covington

We would like to acknowledge KYTC District 6 for obtaining traffic counts, KYTC Central Office for performing traffic forecasting, and OKI for allowing the use of their traffic forecasting model. Their contributions to this study are appreciated.

Committee Members

Adam Kirk, P.E., PTOE, AICP	Engineer Associate II/Research, KTC – UK
Andrew C. Aiello, AICP	Assistant Director – Communication and Development, TANK
Brent A. Sweger, P.E.	Transportation Planning Engineer, KYTC – Planning
David Hamilton, P.E.	Transportation Engineer, KYTC
Edward Dietrich	Associate Planner, NKAPC
Keith D. Logsdon, AICP	Deputy Director for Long Range Planning, NKAPC
Larry Klein	Chief Administrative Officer, City of Fort Wright
Laura Mitchell, P.E.	Transportation Engineer, NKAPC
Mike Bezold, P.E.	District 6 Planning Engineer, KYTC – District 6
Thomas H. Logan, P.E.	City Engineer, City of Covington

MADISON PIKE (KY 17) INTERSECTION IMPROVEMENT STUDY

TABLE OF CONTENTS

SECTION 1 – INTRODUCTION AND BACKGROUND..... 1

 1.0 Introduction..... 1

 1.1 Project Purpose..... 1

 1.2 History of Project Development..... 1

 1.3 Project Area..... 2

SECTION 2 – EXISTING CONDITIONS..... 3

 2.0 Introduction..... 3

 2.1 Existing Traffic Volumes..... 3

 2.2 Traffic Operations..... 3

 2.3 Crash Data..... 6

 2.4 Utilities..... 6

SECTION 3 – FUTURE CONDITIONS..... 7

 3.0 Introduction..... 7

 3.1 Future Land Use..... 7

 3.2 Traffic Projections..... 7

 3.3 Traffic Operations..... 8

SECTION 4 – ROAD IMPROVEMENT ALTERNATIVES..... 10

 4.0 Introduction..... 10

 4.0.1 Signal Options..... 10

 4.0.2 Roundabout Options..... 11

 4.0.3 Level of Service..... 11

 4.0.4 Reserve Capacity Analysis..... 12

 4.1 Comparative Analysis of Intersection Improvements..... 12

 4.1.1 Holds Branch Road / Pioneer Park..... 12

 4.1.2 Old Madison Pike..... 16

 4.1.3 TANK Facility / Lakeview Drive..... 20

SECTION 5 – RECOMMENDATIONS..... 26

 5.0 Introduction..... 26

 5.1 General Recommendation..... 26

 5.2 Holds Branch Road / Pioneer Park..... 26

 5.3 Old Madison Pike..... 27

 5.4 TANK Facility / Lakeview Drive..... 28

 5.5 Other Recommendations..... 28

SECTION 6 - REFERENCES..... 30

TABLE OF CONTENTS, *continued*

TABLES

Table 1:	Existing Traffic Volumes	3
Table 2:	Level of Service Criteria – Signalized	4
Table 3:	Level of Service Criteria – Unsignalized.....	4
Table 4:	Existing Level of Service	5
Table 5:	Future Traffic Volumes	8
Table 6:	Future Level of Service – No Build	9
Table 7:	Future Level of Service – Alternatives.....	11
Table 8:	Reserve Capacity Analysis.....	12
Table 9:	Alternatives Evaluation Matrix	24 - 25

FIGURES

Figure 1:	Project Location Map
Figure 2:	Project Area / Utilities (Holds Branch Road / Pioneer Park)
Figure 3:	Project Area / Utilities (Old Madison Pike)
Figure 4:	Project Area / Utilities (TANK Facility / Lakeview Drive)
Figure 5:	Signalized Concept Drawing (Holds Branch Road / Pioneer Park)
Figure 6:	Roundabout Concept Drawing (Holds Branch Road/Pioneer Park)
Figure 7:	Signalized Concept Drawing (Old Madison Pike)
Figure 8:	North Bypass Lanes Signalized Concept Drawing (Old Madison Pike)
Figure 9:	Roundabout Concept Drawing (Old Madison Pike)
Figure 10:	Signalized Concept Drawing (TANK Facility / Lakeview Drive)
Figure 11:	Roundabout Concept Drawing (TANK Facility / Lakeview Drive)

APPENDICES

Appendix A:	KYTC Traffic Forecast
Appendix B:	SYNCHRO Outputs for Traffic Signals
Appendix C:	Design Criteria
Appendix D:	RODEL Outputs for Modern Roundabouts
Appendix E:	Cost Estimates

SECTION 1 – INTRODUCTION AND BACKGROUND

1.0 INTRODUCTION

The Madison Pike (KY 17) Intersection Improvement Study was conducted by DLZ Kentucky, Inc. and CDS Associates for the Northern Kentucky Area Planning Commission (NKAPC) in conjunction with the Kentucky Transportation Cabinet (KYTC) to assess potential improvements at the intersections of (1) Madison Pike and Holds Branch Road / Pioneer Park, (2) Madison Pike and Old Madison Pike, and (3) Madison Pike and the Transit Authority of Northern Kentucky (TANK) Facility Entrance / Lakeview Drive. Coordination with the City of Fort Wright, City of Covington, and TANK was also required for this study. Madison Pike is a north-south route with the study intersections lying in the cities of Fort Wright and Covington in Kenton County, Kentucky (Figure 1).

Assess potential improvements at the intersections

To increase capacity and manage congestion, the study team considered two alternatives for each intersection: installation of a traffic signal with widening and construction of a modern roundabout. The report is broken into five main sections, each of which describes an important element of the study. They are as follows:

1. Introduction and Background Information
2. Evaluation of Existing Conditions
3. Evaluation of Future Conditions
4. Comparison of Potential Intersection Improvements
5. Recommendations

1.1 PROJECT PURPOSE

The main purposes of the Madison Pike Intersection Improvement Study are to:

- Identify existing and potential future traffic operations and safety problems at the three study intersections.
- Identify and evaluate potential intersection improvements.
- Compare improvement options and identify a recommended course of action.

In order to meet the purposes of this project, a study was undertaken by NKAPC's consultant, DLZ Kentucky, Inc (DLZ). The following sections of the report describe the study.

1.2 HISTORY OF PROJECT DEVELOPMENT

The *Madison Pike Intersection Improvement Study* is a direct outcome of an earlier study – the *Madison Pike Corridor Land Use and Economic Development Plan* (NKAPC, 2005).

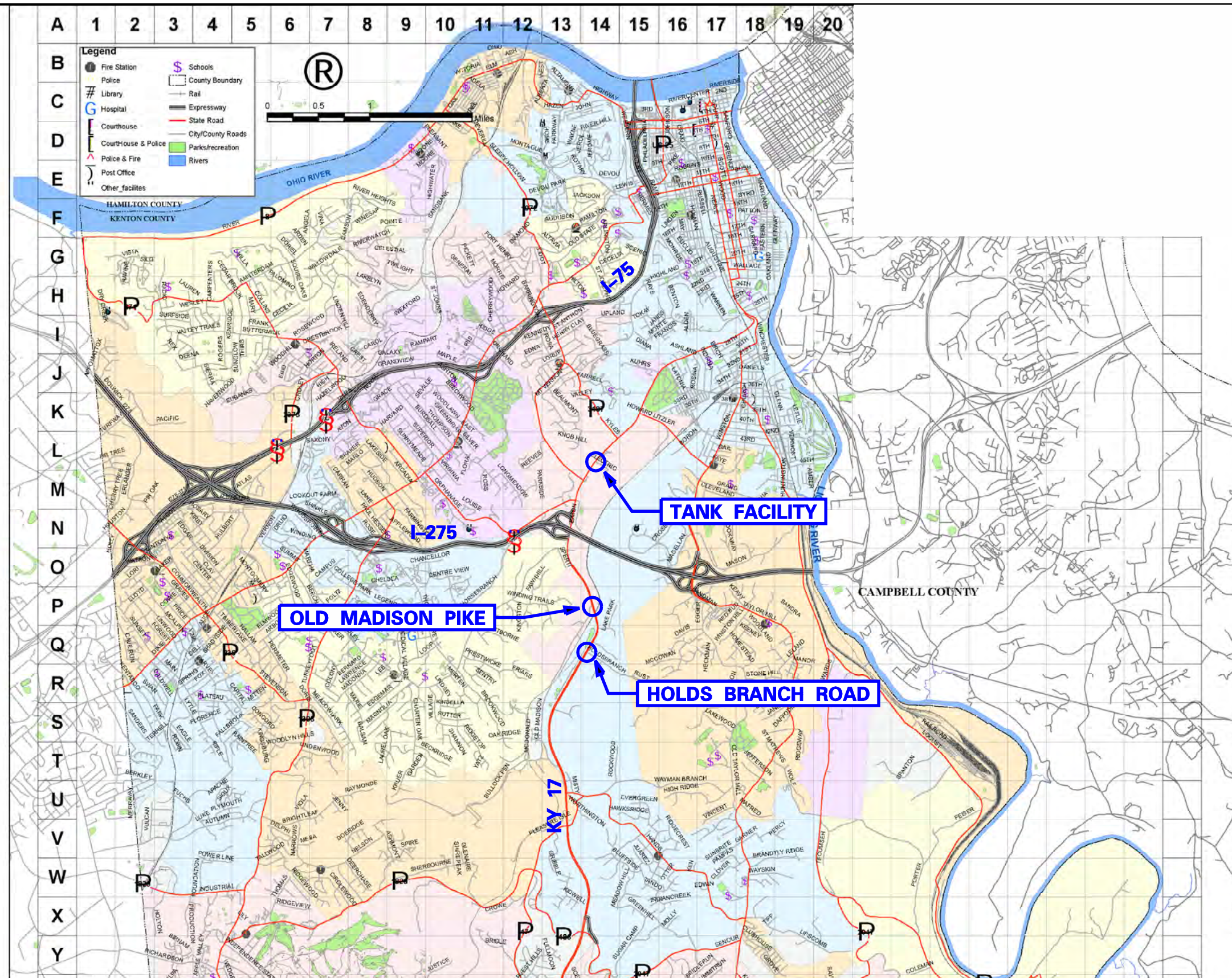

MADISON PIKE (KY17) INTERSECTION IMPROVEMENT STUDY

FIGURE 1 – PROJECT LOCATION MAP



DLZ KENTUCKY, INC.
 201 BRIGHTON PARK BLVD.
 FRANKFORT, KY 40601
 (502) 695-2300 (Fax) 695-1497

This intersection improvement study addresses several specific issues discussed in Chapter 6 (Transportation) of the *Madison Pike Corridor Land Use and Economic Development Plan*.

The *Corridor Land Use and Economic Development Plan* report highlighted concerns related to adding new traffic signals on Madison Pike. This roadway is an arterial highway where high free flow speeds are desired. The concern was that additional traffic signals could impair the overall performance of the corridor.

The *Madison Pike Corridor Land Use and Economic Development Plan* recommends consideration of roundabouts in lieu of traffic signals at Madison Pike and Old Madison Pike, and Madison Pike and the TANK Facility Entrance / Lakeview Drive. The *Madison Pike Intersection Improvement Study* examines this recommendation in detail.







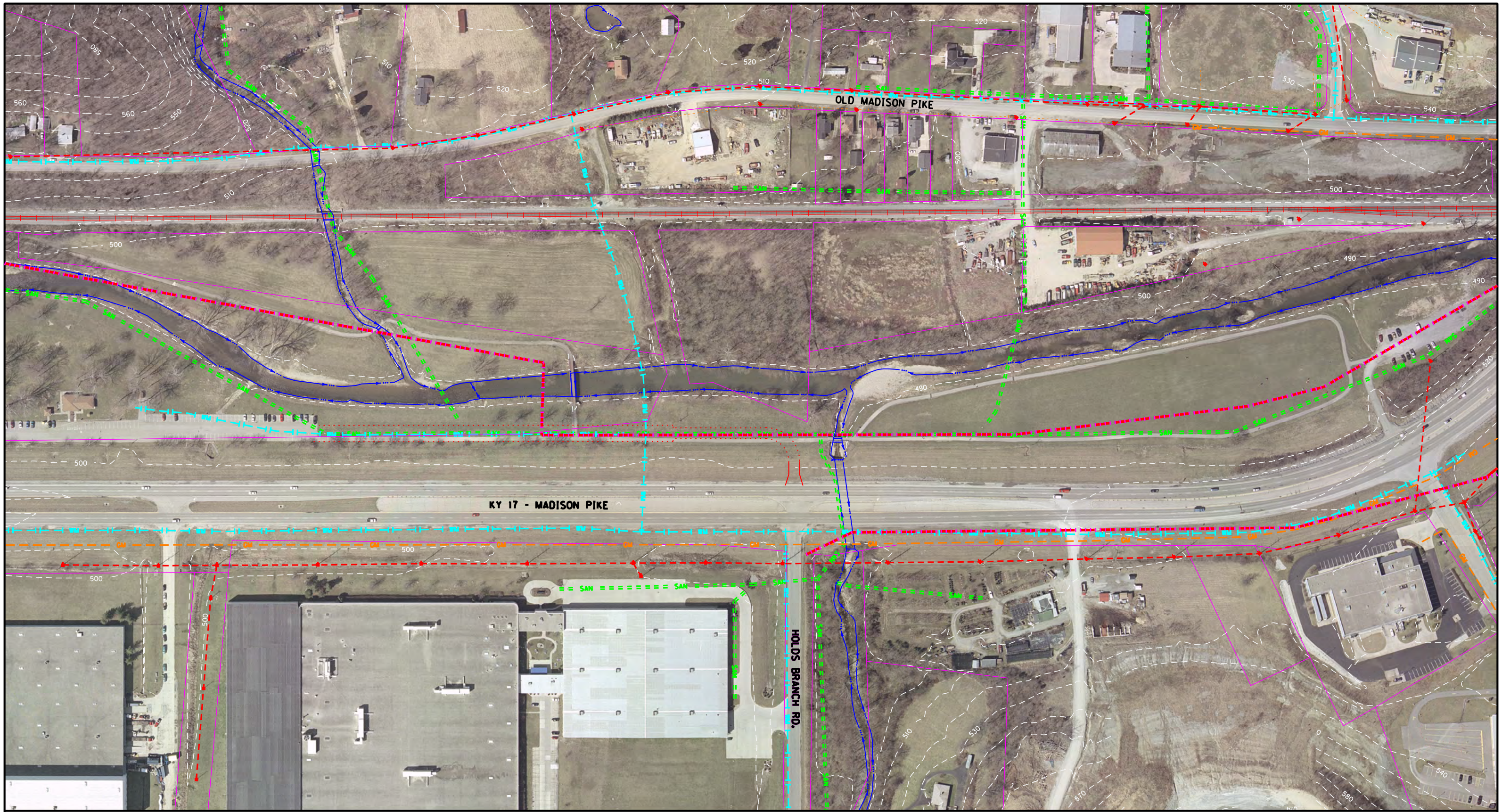



A third intersection, Madison Pike and Hold Branch Road, was added to the *Madison Pike Intersection Improvement Study* through a cooperative agreement among several parties. This agreement made available funds for study of the third intersection. The Kentucky Transportation Cabinet obtained traffic counts for the three study intersections. OKI provided the traffic forecasting model used by KYTC to develop future traffic flows. The existing and future traffic flows were provided to the project team.

1.3 PROJECT AREA

Figure 1 is a location map showing the three study intersections. Each intersection is shown in more detail with a project area map. The project area includes the intersections of Madison Pike and Holds Branch Road / Pioneer Park (Figure 2), Madison Pike and Old Madison Pike (Figure 3), and Madison Pike and the TANK Facility Entrance / Lakeview Drive (Figure 4). The overall Madison Pike Corridor and road segments between the three study intersections were not evaluated as part of this study.



LEGEND

-  EX. GAS MAIN
-  EX. SANITARY SEWER
-  EX. WATER MAIN
-  EX. STREAMLINE
-  EX. ELECTRIC
-  EX. RAILROAD
-  PROPOSED ACCESS ROAD
-  PROPOSED BIKE PATH
-  EX. CONTOUR
-  PROPERTY LINE

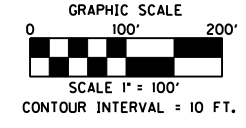

FIGURE 2
PROJECT AREA AND UTILITIES
KY 17 – MADISON PIKE
@ HOLDS BRANCH ROAD



DLZ KENTUCKY, INC.
 201 BRIGHTON PARK BLVD.
 FRANKFORT, KY 40601
 (502) 695-2300 (Fax) 695-1497

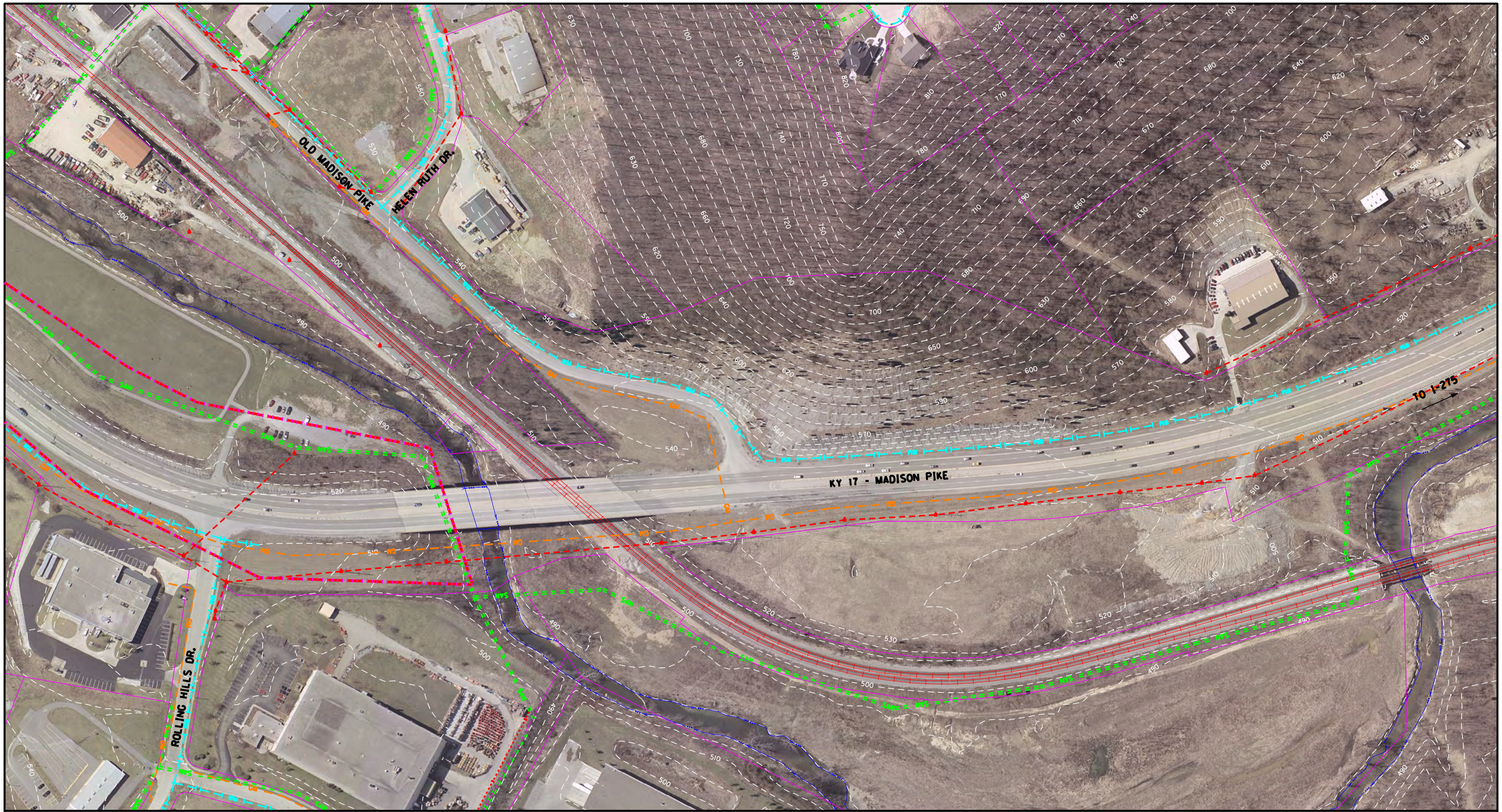
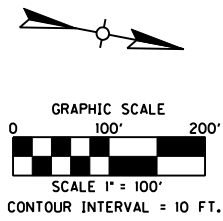

FIGURE 3
PROJECT AREA AND UTILITIES
KY 17 – MADISON PIKE
@ OLD MADISON PIKE

LEGEND











- EX. GAS MAIN
- EX. SANITARY SEWER
- EX. WATER MAIN
- EX. STREAMLINE
- EX. ELECTRIC
- EX. RAILROAD
- PROPOSED ACCESS ROAD
- PROPOSED BIKE PATH
- EX. CONTOUR
- PROPERTY LINE



DLZ KENTUCKY, INC.
 201 BRIGHTON PARK BLVD.
 FRANKFORT, KY 40601
 (502) 695-2300 (Fax) 695-1497



LEGEND

-  EX. GAS MAIN
-  EX. SANITARY SEWER
-  EX. WATER MAIN
-  EX. STREAMLINE
-  EX. ELECTRIC
-  EX. RAILROAD
-  PROPOSED ACCESS ROAD
-  PROPOSED BIKE PATH
-  EX. CONTOUR
-  PROPERTY LINE

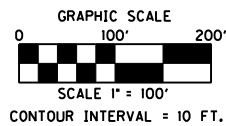

FIGURE 4
PROJECT AREA AND UTILITIES
KY 17 – MADISON PIKE
@ TANK ENTRANCE



DLZ KENTUCKY, INC.
 201 BRIGHTON PARK BLVD.
 FRANKFORT, KY 40601
 (502) 695-2300 (Fax) 695-1497

SECTION 2 – EXISTING CONDITIONS

2.0 INTRODUCTION

The assessment of existing peak hour traffic conditions at the study intersections is an important step in the study process. In order to perform this evaluation, existing traffic counts (including turning movements) for the three intersections were obtained by KYTC and provided to the project team. In addition to traffic operations, crash data was also requested from KYTC and examined to determine if safety problems exist at these intersections. This section of the report describes the methods used for evaluation and the results of the existing conditions analysis. It should be noted that off-peak traffic operations were not analyzed as part of this study. Only peak hour analysis was performed for each intersection since traffic volumes during the peak hour are higher than any off-peak hour. Therefore, if road improvements accommodate peak hour traffic at an acceptable level, off peak traffic operations will also be acceptable.

2.1 EXISTING TRAFFIC VOLUMES

The Kentucky Transportation Cabinet obtained existing traffic volumes for the three study intersections in January 2006. These counts were evaluated, and a peak traffic hour volume for both the morning and evening was determined. This process is explained in more detail in Appendix A. These peak hour traffic counts were then supplied to DLZ for analysis. Table 1 shows the results of the peak hour traffic counts as represented by a total number of vehicles entering each intersection within the peak hours.

Table 1: Existing (2006) Intersection Traffic Volumes

Intersection	AM Peak Hour Total Entering Volume	AM Directional Split % (SB/NB)	PM Peak Hour Total Entering Volume	PM Directional Split % (SB/NB)
Madison Pike - Holds Branch Road / Pioneer Park	3690	20 / 80	3495	69 / 31
Madison Pike - Old Madison Pike	4420	23 / 77	4200	66 / 34
Madison Pike - TANK Facility / Lakeview Drive	2270	33 / 67	2350	53 / 47

2.2 TRAFFIC OPERATIONS

Using the peak hour turning movement counts (diagrams shown in Appendix A), a computer traffic model was developed for each study intersection using the SYNCHRO program. This program develops a peak hour model that accounts for interaction of movements and can reflect the impacts of minor changes in intersection geometry, traffic signal timing changes, and traffic operations strategies. Each intersection was analyzed for the existing year (2006) information provided by KYTC to determine the effectiveness of the current intersection control. The most common measure of intersection performance is Level Of Service (LOS). A brief description of LOS for signalized intersections is given in Table 2. The LOS criteria

for unsignalized intersections can be found in Table 3 and are similar to that of signalized intersections.

Table 2: Level of Service Criteria - Signalized Intersections

LOS	Seconds Delay/Vehicle	Description
A	≤ 10	Most vehicles do not stop at all.
B	> 10 and ≤ 20	More vehicles stop than for LOS A.
C	> 20 and ≤ 35	The number of vehicles stopping is significant, although many pass through without stopping.
D	> 35 and ≤ 55	Many vehicles stop. Individual cycle failures are noticeable.
E	> 55 and ≤ 80	Considered being the limit of acceptable delay. Individual cycle failures are frequent.
F	> 80	Unacceptable delay.

Source: Transportation Research Board, Highway Capacity Manual, 2000

Table 3: Level of Service Criteria - Unsignalized Intersections

LOS	Seconds Delay/Vehicle	Description
A	≤ 10	Little or no delay, very low main street traffic.
B	> 10 and ≤ 15	Short traffic delays, many acceptable gaps.
C	> 15 and ≤ 25	Average traffic delays, frequent gaps still occur
D	> 25 and ≤ 35	Long traffic delays, limited number of acceptable gaps.
E	> 35 and ≤ 50	Very long traffic delays, very small number of acceptable gaps.
F	> 50	Extreme traffic delays, virtually no acceptable gaps in traffic.

Source: Transportation Research Board, Highway Capacity Manual, 2000

The Holds Branch Road / Pioneer Park and Madison Pike intersection (Figure 2) recently became a signalized intersection to accommodate improvements at Pioneer Park and a planned development on Holds Branch Road containing over 1000 dwelling units and commercial development. This development helped drive the decision to incorporate this intersection into the study. Northbound and southbound Madison Pike has two lanes each for through movement. The southbound leg has a left turn lane to turn onto Holds Branch Road. The roadway segment south of the intersection has a center median; with no left turn lane since the Pioneer Park leg is an exit only. Holds Branch is currently a two-lane road. The site plan approved for the development on Holds Branch Road includes the addition of a right turn lane from northbound Madison Pike into Holds Branch Road and an acceleration lane for vehicles turning right (north) from Holds Branch Road onto Madison Pike. These lanes were not used in the analysis as they have not yet been constructed.

The intersection of Madison Pike and Old Madison Pike (Figure 3) is currently a stop-controlled intersection. The stop-control only occurs for eastbound traffic (Old Madison Pike). Currently, northbound and southbound have two through lanes with a northbound left turn lane for access to Old Madison Pike. There is no designated right turn access to Old

Madison Pike from the southbound direction. Old Madison Pike is a two-lane road and there is currently no access to the property east of the intersection.

The intersection of Madison Pike and the TANK Facility Entrance (Figure 4) is currently a stop-controlled intersection. The stop-control only occurs for westbound traffic (TANK Entrance). Currently, northbound and southbound have two through lanes with a 14-foot continuous left turn lane. There is no designated right turn lane for the northbound direction. Lakeview Drive access is currently situated approximately 200 feet from the TANK Entrance. The TANK Entrance shares its access with Brooks Drive, which is a small (one lane) access road used by Duke Energy. There is currently no access to the property west of the intersection.

Each intersection was analyzed using a base model. This base model incorporated such factors as current lane configurations, signal timings, posted travel speeds, intersection controls, and other characteristics specific to that intersection. The existing peak hour traffic volumes for each intersection were then input into the corresponding SYNCHRO base file and evaluated for the existing condition. Each SYNCHRO model was then used to generate an output report, which can be found in Appendix B. Table 4 summarizes the results of the analysis of the existing signalized intersections.

Table 4: Existing (2006) LOS (Average Delay in Seconds)

Intersection	AM Peak Hour LOS	PM Peak Hour LOS
Madison Pike and Holds Branch Road / Pioneer Park	D (38.2)	A (6.9)
Madison Pike and Old Madison Pike	F (111.0)	F (>max) ¹
Madison Pike and TANK Facility / Lakeview Drive	D (34.9)	E (39.9)

¹ In the PM Peak Hour Analysis for Old Madison Pike, an error was given by the SYNCHRO analysis for the delay to the approach road. An error occurs when the delay exceeds a specified value – in this case, 9999 seconds. Essentially, the analysis indicates that there are no acceptable gaps during the PM peak to allow traffic from Old Madison Pike to turn on to Madison Pike. Therefore the “>max” is used to show the delay.

At the intersection of Madison Pike and Holds Branch Road, the current configuration seems to perform at a reasonable level since the current signal is actuated. The PM peak analysis shows that the intersection is estimated to operate at LOS A with a 6.9 second average delay. However, there is still considerable delay in the AM peak for the northbound through movement (46.5 sec, LOS D) as well as to the traffic on Holds Branch Road (54.6 sec, LOS D). The discrepancy between the AM and PM LOS can be attributed to the AM peak northbound traffic volume of 2,880 vehicles per hour, compared to 1,050 vehicles per hour in the northbound direction during the PM peak hour. The heavy northbound through movement in the AM peak hour adversely impacts signal timing for other turn movements in the intersection, thus operating at a lower Level of Service.

Heavy northbound movement adversely impacts other turn movements

The evaluation of the intersection of Madison Pike and Old Madison Pike, on the other hand, revealed considerable delays to traffic on Old Madison Pike in both the AM and PM peak. The LOS shown in Table 4 reflects delay to the leg that is stop-controlled (in this case, Old

Madison Pike). Madison Pike northbound and southbound movements are free flow with no delays.

The intersection of Madison Pike and the TANK Facility also experiences delay for the stop-controlled leg (TANK Entrance). Again, Madison Pike northbound and southbound movements are free flow. These delays are also noted in Table 4.

2.3 CRASH DATA

In addition to the existing traffic data, crash data was requested from KYTC and evaluated to determine if crash countermeasures would be appropriate. The data provided by KYTC included accident reports for the Madison Pike Corridor from 0.5 miles south of Holds Branch Road to 0.5 miles north of the TANK facility for the years 2003, 2004, and 2005. The data provided contained approximately 330 accidents.

While there were several accident reports for the Madison Pike Corridor, there were minimal reports located within 500 feet in either direction of the study intersections. Of the 330 reports, there were no accidents reported in the vicinity of Holds Branch Road, four (4) accidents reported near Old Madison Pike, and only three (3) reported at the TANK Facility Entrance. There were no fatalities in the 7 accidents reported near the study intersections, and only one injury accident. The existing statistical information at these intersections does not appear to indicate a safety problem with one accident per 3.5 million vehicles entering the Madison Pike and TANK Facility entrance intersection and one accident per 10 million vehicles entering the Madison Pike and Old Madison Pike intersection. However, with the increasing traffic and congestion at these intersections, the potential exists for an increased accident rate.

Another area of potential concern is the TANK exit located just south of the TANK Facility Entrance. This requires buses turning south from TANK to either wait for an adequate gap in both directions or turn into the continuous left turn (center) lane until there is an adequate southbound gap.

2.4 UTILITIES

Several utility companies have facilities near the locations of the study intersections. These utilities include Duke Energy (gas and electric) and Cincinnati Bell (telephone). These utility companies were contacted by DLZ to determine the location of any facilities they may have in the area in order to assess potential impacts due to improvement alternatives. All contacts responded and provided maps indicating approximate locations of facilities. These locations, in relation to each intersection, are shown on Figures 2, 3, and 4.

SECTION 3 – FUTURE CONDITIONS

3.0 INTRODUCTION

As a result of ongoing and planned development, the future traffic demands on the study intersections were assessed using a revised SYNCHRO model. The revised SYNCHRO model used the existing condition model as a base but added projected future traffic volumes. The objective was to define peak hour traffic operations issues that could occur in the year 2030 without any road improvements (i.e. “No Build” scenario).

This evaluation highlights potential future traffic issues that should be addressed with intersection improvements such as a traffic signal or roundabout. As with the existing conditions evaluation, off-peak traffic operations were not analyzed. Only peak hour analysis was performed for each intersection since traffic volumes during the peak hour are higher than any off-peak hour. Therefore, if road improvements accommodate peak hour traffic at an acceptable level, off peak traffic operations will also be acceptable.

3.1 FUTURE LAND USE

Through discussions with NKAPC and the Cities of Fort Wright and Covington, future land development was anticipated throughout the corridor. In coordination with NKAPC and the City of Fort Wright, each parcel in the corridor was analyzed for future and projected development based on local land use plans. Traffic volumes were then estimated for these developments (estimates obtained using the ITE Trip Generation Manual). This information was incorporated into OKI’s traffic network model to develop future (year 2030) Annual Daily Traffic (ADT) and AM and PM peak hour trips. The future land use table and map are included in Appendix A.

3.2 TRAFFIC PROJECTIONS

Based on the future land uses in the corridor and surrounding areas, KYTC used OKI’s network traffic model for the region to project traffic volumes for each intersection (Diagrams and volumes are in Appendix A) and supplied this information to DLZ for analysis.

The theoretical capacity of a roadway link typically ranges from 1500 to 1900 vehicles per lane per hour (vplph) and depends on site specific factors such as travel speed, density of driveways, driver behavior, median type, etc. Exercising collective professional judgment, the project team assumed a maximum road link capacity of 1700 vplph for planning purposes, with the understanding that KYTC has no plans to add lanes on KY-17. Therefore, the peak hour projected traffic flow was adjusted to allow a maximum of 1700 vplph for all traffic flows except for southbound traffic at Old Madison Pike and Holds Branch Road. The southbound traffic approaching Old Madison Pike and Hold Branch in the PM was further constrained to 1450 vplph due to congestion at the intersection of Madison Pike and Dudley Road which is located approximately 3300 feet north of the Madison Pike / Old Madison

Pike intersection. The Dudley Road intersection would likely prevent traffic flow from reaching 1700 vplph due to the capacity of this intersection.

KYTC indicated that the Dudley Road intersection at Madison Pike may be improved before any of the three intersections in this study, although there are no plans at this time to do so. Because the analysis in this report assumes no improvement to the Madison Pike / Dudley Road intersection (resulting in a maximum southbound flow of 1450 vplph), if this intersection were upgraded (resulting in a southbound flow greater than 1450 vplph), the LOS for nearby intersections would be worse than presented in this report. As a result, it may not be possible to achieve LOS C or even D at the Old Madison Pike and Holds Branch intersections.

The adjusted projected traffic volumes (year 2030) for each intersection are shown in Table 5. Additional information regarding future traffic volumes and turning movement diagrams can be found in Appendix A.

Table 5: Future (year 2030) Projected Traffic Volumes

Intersection	AM Peak Hour Total Entering Volume	AM Directional Split % (SB/NB)	PM Peak Hour Total Entering Volume	PM Directional Split % (SB/NB)
Madison Pike - Holds Branch Road / Pioneer Park	5110	31 / 69	5665	60 / 40
Madison Pike - Old Madison Pike	5400	35 / 65	5745	54 / 46
Madison Pike - TANK Facility / Lakeview Drive	3750	35 / 65	4190	52 / 48

The peak hour factor (PHF) also had to be considered in the analysis of each intersection. The PHF specifies how the peak hour traffic is spread throughout the hour. Due to the existing capacity of the roadway and the constraints placed on the traffic projections, DLZ in collaboration with the project team assumed that the traffic would essentially be balanced throughout the peak hour. From this, the default PHF used was 0.95 with a maximum of 1.00 (equally balanced throughout the hour). Each movement was checked to ensure that the movement combined with the peak hour factor would not exceed the constrained volumes described above. If traffic flow did exceed the allowable limit, the peak hour factor was adjusted to comply with the constraint.

3.3 TRAFFIC OPERATIONS

The “No Build” scenario for the year 2030 was evaluated in order to assess the need for intersection improvements. This “No Build” scenario is the situation that assumes projected population growth and development along and near the corridor and that no road improvements would be performed with the exception of planned access roads. Using the existing conditions SYNCHRO model as a baseline, a traffic model was run using the year 2030 traffic volumes. The future conditions model included the same road network as the existing condition and was first analyzed using the same intersection control that currently exists.

For the Old Madison Pike intersection, an access road was added to the east and analyzed using a stop control for the approaches. These approaches are projected to operate at LOS F with a “>max” delay for both the AM and PM peak hours. An access road was also added to the west of the TANK Facility Entrance and then evaluated for a stop control on the approaches. These approaches were also projected to operate at LOS F with a “>max” delay for both the AM and PM peak hours.

The future conditions model was then analyzed for the “No Build” scenario with a traffic signal using a cycle time of 125 seconds to match existing signals within the corridor. The results of the signalized analysis can be seen in Table 6. The outputs generated from the SYNCHRO program are included in Appendix B.

Table 6: Future (year 2030) No Build Level of Service (average delay in seconds)

Intersection	AM Peak Hour LOS			PM Peak Hour LOS		
	Overall	SB	NB	Overall	SB	NB
Madison Pike - Holds Branch Road	F (206.5)	E (68.6)	F (256.3)	F (177.9)	F (84.3)	E (56.8)
Madison Pike - Old Madison Pike (with signal)	F (120.6)	B (15.3)	F (184.8)	F (93.8)	F (116.0)	E (58.9)
Madison Pike - TANK Facility (with signal)	D (42.9)	C (20.4)	D (44.1)	E (64.8)	D (46.7)	E (74.2)

All intersections examined do not meet the desired LOS C for the year 2030 in the “No Build” scenario during the peak hours. The off-peak operations of these intersections may provide an acceptable level of service, however, the analysis for this study was limited to peak hour traffic operations only.

Additional signal timings were also analyzed to determine the best overall traffic operation under these conditions. Each intersection was evaluated for a 115 second cycle time, a 135 second cycle time and an optimized cycle time for the “No Build” scenario. The optimized cycle time is a feature in SYNCHRO that selects the signal timing for optimal performance. In all situations, the LOS for the intersection was the same. For Holds Branch Road / Pioneer Park, the optimized cycle times were 150 seconds and 75 seconds for the AM and PM peak hours respectively. At Old Madison Pike, the optimized cycle times were 150 seconds for both the AM and PM peak. For the TANK Facility Entrance / Lakeview Dr., the optimized cycle times were 140 seconds for the AM peak and 120 seconds for the PM peak. Any modification to cycle times at one intersection would require modifications to the other signals within the corridor to maintain vehicle platoon movement. All results shown and documented from the SYNCHRO analysis within this report are based on a 125 second cycle time to match existing traffic signals.

SECTION 4 – ROAD IMPROVEMENT ALTERNATIVES

4.0 INTRODUCTION

The development and evaluation of potential road improvements is presented in this section of the report. These road improvements address the peak hour problems identified in the preceding sections of the report. A comparison of road improvement alternatives for future peak hour traffic volumes is also included. The design criteria used to develop improvement alternatives can be found in Appendix C.

The project team discussed the operational goals for the study intersections early in the process. It was decided that each improvement option should achieve LOS C or better if practical. However, the team also agreed that this might not be possible at some locations, and LOS D or even E might have to be accepted. It also became apparent as the study was conducted that reaching LOS C or better at the three study intersections could create unintended traffic congestion at other locations outside the immediate study area. Specifically, allowing more traffic to get through the three project area intersections could result in already-congested downstream intersections and road links becoming overloaded.

For this reason, the project team considered the possibility of managing overall congestion by accepting a lower level of service (i.e., LOS E or F) at the three study intersections. This approach could limit increases in traffic volumes and congestion at other intersections within the KY-17 corridor and on Interstate 275 (traffic would be “bottled up” at selected locations to prevent potentially more serious problems elsewhere). It could also minimize negative impacts and construction costs. Last, it could affect land use and transit patterns in the project area, as noted in the *Madison Pike Corridor Land Use and Economic Development Plan*. However, due to the limited scope of this study, the effects of such an approach upon other intersections could not be evaluated. Also, the interaction between intersections was not evaluated. As described in more detail in the Recommendations section of this report, these issues would be best addressed as part of an overall corridor study.

4.0.1 SIGNAL OPTIONS

Each intersection was initially modified from the “No Build” scenario by adding turn lanes and additional through lanes to Madison Pike and the intersecting streets to operate at LOS C or better. Each option was then analyzed until an overall satisfactory intersection improvement was determined. At two of the intersections (Holds Branch and Old Madison Pike), the standard techniques of adding turn lanes would not obtain a desirable LOS. It became apparent that adding a lane through the intersection would be required to obtain a desirable LOS. A lane widening is increasing the approach of the intersection from two through lanes to three through lanes to enable more vehicles to pass through the intersection during the allotted green time. Upon passing through the intersection the roadway typically decreases from three through lanes back to two through lanes. KYTC recommends the use of approximately 600 feet of storage

Adding through lanes would be required to obtain a desirable LOS

past the intersection (full width lane) and an additional taper length dependent upon the design speed in the area.

The traffic signal improvements options considered many factors related to traffic operations and safety. To maintain a platoon of vehicles traveling from one intersection to another, a traffic signal cycle length of 125 seconds was maintained through this analysis, matching current traffic signals within the corridor. The traffic analysis also utilized different timings for the AM and PM peak hour conditions to increase the efficiency of the traffic signal. The signals were designed in accordance with the *Highway Capacity Manual 2000* (Transportation Research Board).

As part of the traffic signal option analysis, SYNCHRO software was utilized to determine the traffic signal operations and LOS for each intersection. The level of service criteria used is the same as the existing conditions analysis and can be found in Table 2.

4.0.2 ROUNDABOUT OPTIONS

Modern roundabout geometry is influenced by a variety of factors related to traffic operations and safety considerations. After detailed analysis and conceptual design work, the modern roundabouts proposed for the study intersections along KY-17 were developed. Like the signal option, the roundabouts were designed to accommodate year 2030 traffic projections. Additionally, the roundabouts are designed to accommodate AM and PM peak hour volumes. All of the roundabouts were designed in accordance with the Federal Highway Administration’s *Roundabouts: An Informational Guide* (FHWA, 2000) and Ourston’s *Roundabout Design Guidelines* (Ourston, 2001).

As part of the analysis conducted for the roundabout options, RODEL software was used to analyze the future traffic operations and determine the LOS for each intersection. The output generated by RODEL can be found in Appendix D. LOS criteria are summarized in Table 3 for unsignalized intersections.

4.0.3 LEVEL OF SERVICE

Each intersection was evaluated to determine the level of service for the AM and PM peak hours for each alternative (Signalized, Roundabout). This evaluation is used as one criterion in the comparison of alternatives. Table 7 (shown below) will be referenced in subsequent sections of this report.

Table 7: Alternatives Level of Service (average delay in seconds)

Intersection	Signalized		Roundabout	
	AM	PM	AM	PM
Madison Pike and Holds Branch Road / Pioneer Park	C (28.6)	C (30.1)	C (16.8)	B (12.6)
Madison Pike and Old Madison Pike	C (21.4)	C (20.3)	A (2.7)	B (13.7)
Madison Pike and TANK Facility / Lakeview Drive	C (30.2)	C (32.8)	A (5.2)	A (5.8)

Based on future (year 2030) traffic volumes

4.0.4 RESERVE CAPACITY ANALYSIS

The reserve capacity analysis is used to indicate the amount of additional traffic that would be required before an intersection would reach LOS E. Reserve capacities are expressed as the percentage increase in total entering traffic (beyond the 2030 projection) during the controlling peak hour. The controlling peak hour is the peak hour (AM or PM) that provides the least percentage increase in total entering traffic. For this analysis, increases were assumed to occur equally on all legs of the intersection. Table 8 indicates the percentage increase for the controlling peak hour for both alternatives before reaching LOS E and will be referenced in subsequent sections as an evaluation criterion.

Table 8: Reserve Capacity Analysis for Alternatives

Intersection	Signalized	Roundabout
Madison Pike and Holds Branch Road / Pioneer Park	15% (PM)	4% (AM)
Madison Pike and Old Madison Pike	17% (PM)	6% (PM)
Madison Pike and TANK Facility / Lakeview Drive	14% (PM)	23% (AM & PM)

Typically, motorist delay at a roundabout is relatively low until traffic volumes approach capacity. However, once volumes get closer to capacity, delays can increase rapidly, leading to poor LOS. For this reason, it is possible to have a very good LOS (such as A or B) with a low reserve capacity. In this situation, relatively small increases in traffic volumes can result in the intersection having an unacceptable LOS. This is the case at the Madison Pike and Old Madison Pike intersection as well as the Madison Pike and Holds Branch Road intersection.

Delay at a roundabout is relatively low until volumes approach capacity

4.1 COMPARATIVE ANALYSIS OF ROAD IMPROVEMENTS

Table 9, located on pages 24 and 25, is a comparative matrix, which shows the major criteria used in comparing alternatives. All information contained in this section of the report can be found in summary form in Table 9. This matrix was used to provide a recommendation based on the evaluation criteria.

4.1.1 HOLDS BRANCH ROAD / PIONEER PARK

SIGNAL ALTERNATIVE

Geometry

The proposed signalized intersection improvement has three through lanes for northbound and southbound Madison Pike. A dual left turn lane is proposed for Southbound Madison Pike onto Holds Branch Road. Holds Branch Road would be widened to have one left turn lane and two right turn lanes (Figure 5). Since three through lanes in each direction are also

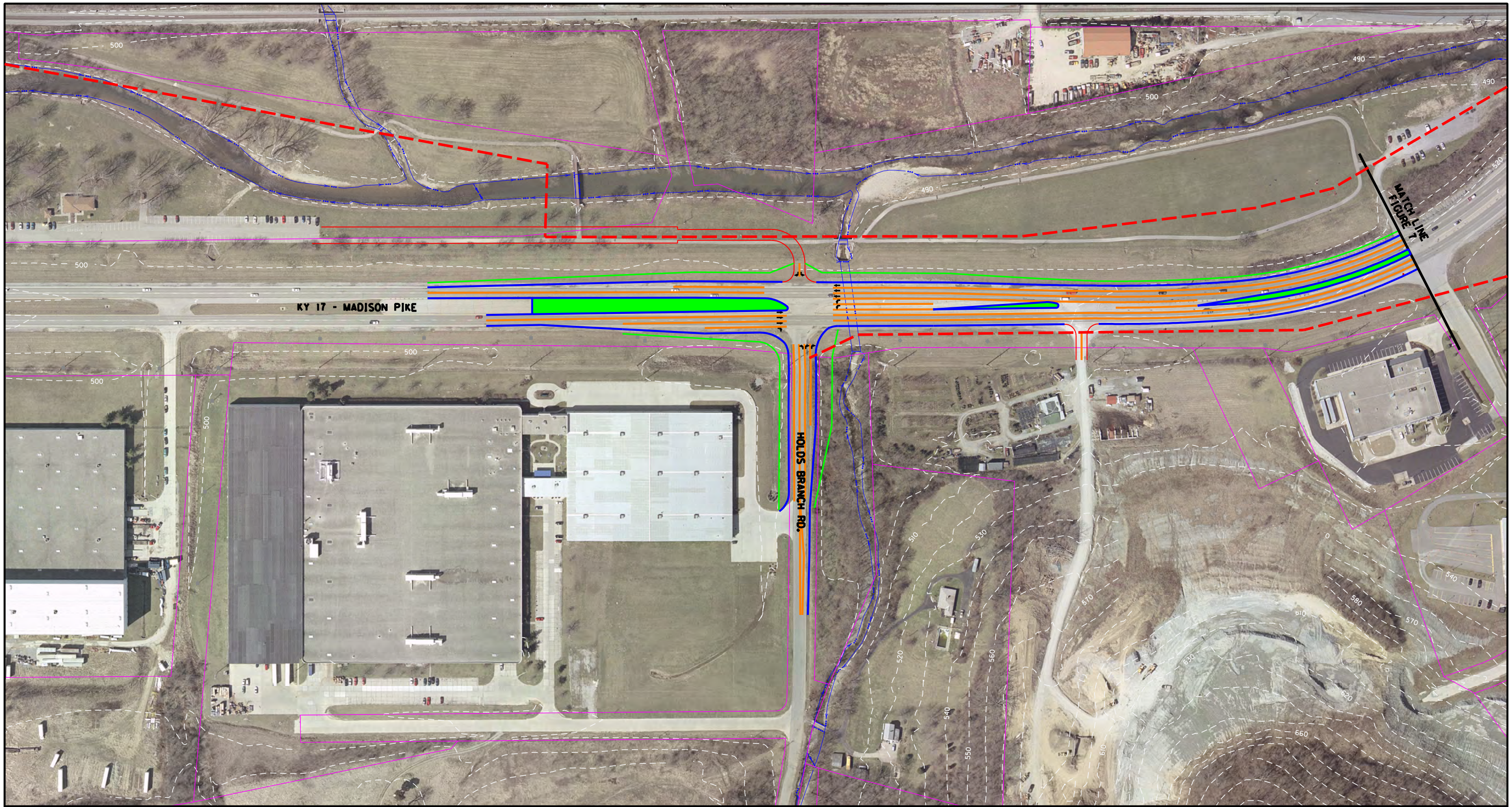

LEGEND









-  PROPOSED LANE MARKINGS
-  PROPOSED EDGE OF PVMT / CURBING
-  PROPOSED EDGE OF DISTURBANCE
-  PROPOSED RETAINING WALL
-  PROPOSED STRUCTURE
-  PROPOSED BIKE PATH
-  EX. CONTOUR
-  PROPERTY LINE

FIGURE 5 – SIGNAL CONCEPT

**KY 17 – MADISON PIKE
@ HOLDS BRANCH ROAD**

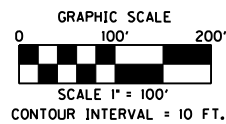

DLZ KENTUCKY, INC.
 201 BRIGHTON PARK BLVD.
 FRANKFORT, KY 40601
 (502) 695-2300 (Fax) 695-1497

required at the intersection with Old Madison Pike, this cross section widening would be extended from the Holds Branch intersection to Old KY 17 to maintain continuity.

Traffic Operations

The improved signalized intersection is projected to operate at LOS C in the year 2030 with an average delay of 28.6 seconds in the AM Peak Hour. During the PM peak hour the improved signalized intersection is estimated to operate at LOS C with an average delay of 30.1 seconds (Table 7). The majority of the delay from the AM and PM peaks can be attributed to the westbound approach (Holds Branch Road), which is estimated to operate at LOS E (64.5 seconds of delay) and LOS E (55.3 seconds of delay) respectively. During the AM and PM peaks, northbound and southbound traffic show considerable volumes, therefore, the signal was timed to allow north and south traffic to flow as freely as possible. The signal alternative would have a reserve capacity of 15 percent (Table 8) during the controlling peak hour (PM).

Safety

This intersection does not currently have a high crash frequency. The installation of modified signal layout at this location with the additional traffic volumes projected would create a similar situation to other signalized intersections within the corridor. The addition of pedestrian crosswalks and a signal phase that is pedestrian actuated (push button) could be incorporated into the signal option. The extended green time required for pedestrian crossing would likely impact the operation of the intersection, however, the effects would likely be temporary with normal operations/delays returning after three or four signal cycles.

Right-of-Way

This alternative would require an additional 0.6 acres of right-of-way. No relocations would be required as a result of the signal alternative. No parking will be impacted by the signal alternative. Because this is a planning level cost estimate with many details still unknown, a right-of-way cost estimate was not prepared.

Cost

Planning level cost estimates are in year 2006 dollars and include construction (with water line relocation) and engineering costs. Utility company facilities that are located within the state right of way are the responsibility of the utility company to relocate and have therefore not been estimated. An additional 15% was included for miscellaneous construction items in order to cover any smaller construction items that have not yet been quantified. Contingency was also added (20%) for material cost fluctuations and unforeseen items. Planning level cost estimates can be found in Appendix E. Planning level costs will total \$2,500,000 for this alternative and are as follows:

- Construction – \$2,100,000
- Engineering – \$400,000

Operational costs will be minimal and will include periodic maintenance.

Driveways / Access

There is currently an existing access with planned improvements approximately 600 feet north of the intersection on the east side of Madison Pike. A traffic impact analysis should

be conducted to determine the most desirable type of access for this intersection. The visibility of and the driveway to the business located on Holds Branch Road will remain the same.

Impacts

The signal alternative would have minor impacts to existing utilities in the area, including water mains and electric. This option should have no impact on the sanitary sewer or gas mains. Most of these impacts occur near the intersection. The tributary to Banklick Creek may require a channel change depending on the direction of widening for Holds Branch Road. A retaining wall is also an option to avoid significant impacts to this tributary. Construction will cause notable delays and congestion, and access to businesses would be impacted.

Aesthetics

The signal alternative would result in minimal negative impact on the adjacent area. The additional pavement required for the intersection will reduce existing green space in the adjacent area.

ROUNDABOUT ALTERNATIVE

Geometry

The Madison Pike and Holds Branch Road roundabout would be a four-leg roundabout with the eastbound leg containing an approach to the roundabout with no exit from the roundabout to access Pioneer Park. The roundabout would require three lane entries on the northbound, eastbound, and southbound approaches. The westbound leg would require two right turn semi-bypass lanes and one entry lane for left turn movements (Figure 6). The roundabout would have a diameter of 260 feet.

Traffic Operations

The roundabout intersection is projected to operate at a LOS C for the AM peak hour with an average delay of 16.8 seconds. The roundabout intersection for the PM peak hour is estimated to operate at LOS B with an average delay of 12.6 seconds (Table 7). Reserve capacity was also analyzed for each alternative. The roundabout alternative would have a reserve capacity of 4 percent (Table 8) during the controlling peak hour (AM). With roundabouts, once volumes get closer to capacity, delays can increase rapidly, leading to poor LOS. For this reason, it is possible to have a very good LOS (such as A or B) with a low reserve capacity. In this situation, relatively small increases in traffic volumes can result in the intersection having an unacceptable LOS.

Safety

As a general rule, modern roundabouts are very safe for automobiles, pedestrians, and bicyclists. Modern roundabouts, when designed properly, are significantly safer for automobiles than signalized intersections as the injury crash rate is about half that of signalized options. Although the total crash frequency for this three-lane roundabout could be near what would be seen with a signal, the injury crash frequency would be notably lower.

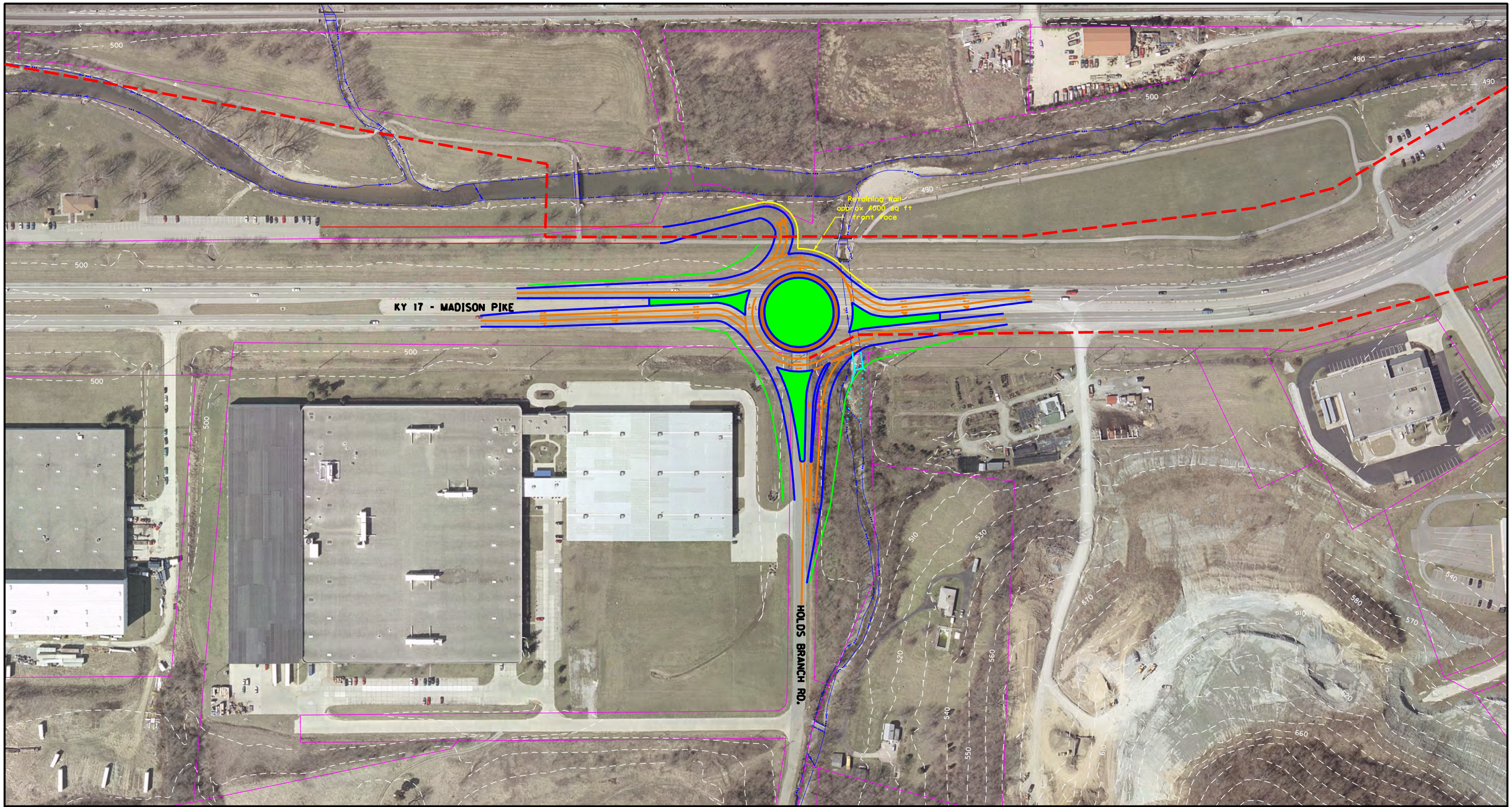

KY 17 - MADISON PIKE

HOLDS BRANCH RD.

Retaining Wall
approx 400 sq ft
front face

LEGEND









-  PROPOSED LANE MARKINGS
-  PROPOSED EDGE OF PVMT / CURBING
-  PROPOSED EDGE OF DISTURBANCE
-  PROPOSED RETAINING WALL
-  PROPOSED STRUCTURE
-  PROPOSED TRUCK APRON
-  PROPOSED BIKE PATH
-  EX. CONTOUR
-  PROPERTY LINE

FIGURE 6 - ROUNDABOUT CONCEPT

**KY 17 - MADISON PIKE
@ HOLDS BRANCH ROAD**

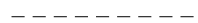
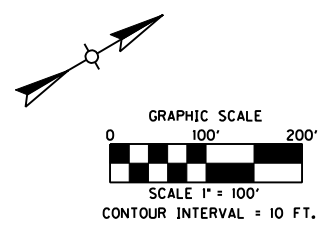

DLZ
DLZ KENTUCKY, INC.
201 BRIGHTON PARK BLVD.
FRANKFORT, KY 40601
(502) 695-2300 (Fax) 695-1497

Roundabouts as a general class have many safety benefits for pedestrians (a reduction in the number of vehicle/pedestrian conflict points, slower vehicle speeds, and a splitter island refuge that separates the directions of traffic and shortens the distance a pedestrian must cross). Studies (mostly involving single and two lane roundabouts) have shown a substantial reduction in both the severity and number of pedestrian crashes when modern roundabouts are installed in place of other intersection controls (Lalani, 1975). However, there is not specific data available which evaluates the safety performance of three lane roundabouts such as the one at this intersection.

It is generally believed that three lane roundabouts are not as pedestrian-friendly as two and single lane roundabouts and may not provide the same degree of benefit as single and two lane roundabouts. However, the situations that require the use of three lane roundabouts (i.e., heavy traffic flows) would typically result in signalized intersections that are not pedestrian friendly either. In the situation at hand, the benefits of a roundabout over a traffic signal may not be substantial. At some roundabouts with heavy traffic flows and significant numbers of pedestrians, pedestrian-actuated signals are installed. Such an option could be investigated here if the roundabout option were advanced for further study. Use of such a signal close to the roundabout would need to be evaluated carefully to assure that traffic operations are not seriously impacted as a result.

Although modern roundabouts may not improve safety for bicyclists, it is generally believed that, if the proper facilities are installed, roundabouts are at least as safe as signalized intersections for bicyclists.

Right-of-Way

This alternative would require an additional 1.1 acres of right-of-way with additional land from Pioneer Park (the property used for Pioneer Park is already state-owned right-of-way, and Kenton County holds a lease to use the land). No relocations would be required as a result of the roundabout alternative. No parking will be impacted by the roundabout alternative. Because this is a planning level cost estimate with many details still unknown, a right-of-way cost estimate was not prepared.

Cost

Planning level cost estimates are in year 2006 dollars and include construction (with water line relocation) and engineering costs. Utility company facilities that are located within the state right of way are the responsibility of the utility company to relocate and have therefore not been estimated. An additional 15% was included for miscellaneous construction items in order to cover any smaller construction items that have not yet been quantified. Contingency was also added (20%) for material cost fluctuations and unforeseen items. Planning level cost estimates can be found in Appendix E. Planning level costs will total \$4,100,000 for this alternative and are as follows:

- Construction – \$3,400,000
- Engineering – \$700,000

Operational costs will be minimal and will include periodic maintenance.

Driveways / Access

The existing driveway to the north of the intersection (on the east side) could be treated in the same way as the signalized option (full access). Another option could be to allow ¾ access (i.e., right-in / right-out / left-in) with left-outs handled as u-turns through the median to the north. If this option was selected, the median width would need to be evaluated and could possibly require widening to safely accommodate u-turns. The business located along Holds Branch Road will maintain the same visibility and driveway access on Holds Branch Road.

Impacts

The roundabout alternative would have significant impacts to existing utilities in the area, including water mains and sanitary sewers. Most of these impacts occur near the intersection. The tributary to Banklick Creek would require a culvert extension and a possible channel change. A retaining wall is also an option to avoid significant impacts to this tributary. Construction will cause notable delays and congestion.

Aesthetics

The modern roundabout alternative would provide opportunities for aesthetic enhancement. These opportunities would come from the green space in the splitter islands and the central island. Roundabouts are often used as “gateway” improvements for communities. In these instances, the central island of the roundabout can contain a variety of features to contribute to the aesthetic setting.

4.1.2 OLD MADISON PIKE

SIGNAL ALTERNATIVE

Geometry

The proposed intersection improvement utilizing additional lanes with a traffic signal is shown in Figure 7. An additional through-right turn lane was added to the southbound direction, an additional through-right turn lane was added to the northbound, and two lanes were used for the eastbound (Old Madison Pike) and westbound approaches. The westbound approach is a potential new access to the property located east of the intersection in anticipation of future development. The widening for the south leg of the intersection extends to the Holds Branch Road intersection. The lane widening proposed with this configuration will require widening of the bridge located south of the intersection. All evaluations contained within section 4.2.1 are related to this signalized configuration.

Traffic Operations

The improved signalized intersection is projected to operate at LOS C in the year 2030 with an average delay of 21.4 seconds in the AM Peak Hour. During the PM peak hour the improved signalized intersection is estimated to operate at LOS C with an average delay of 20.3 seconds (Table 7). The majority of the delay from the AM and PM peaks can be attributed to the eastbound approach (Old Madison Pike), which is estimated to operate at LOS E (66.6 seconds of delay) and LOS E (64.3 seconds of delay) respectively and the westbound approach (future access), which is projected to operate at LOS E (63.0 seconds of delay) and LOS E (65.9 seconds of delay) respectively. The signal was timed to

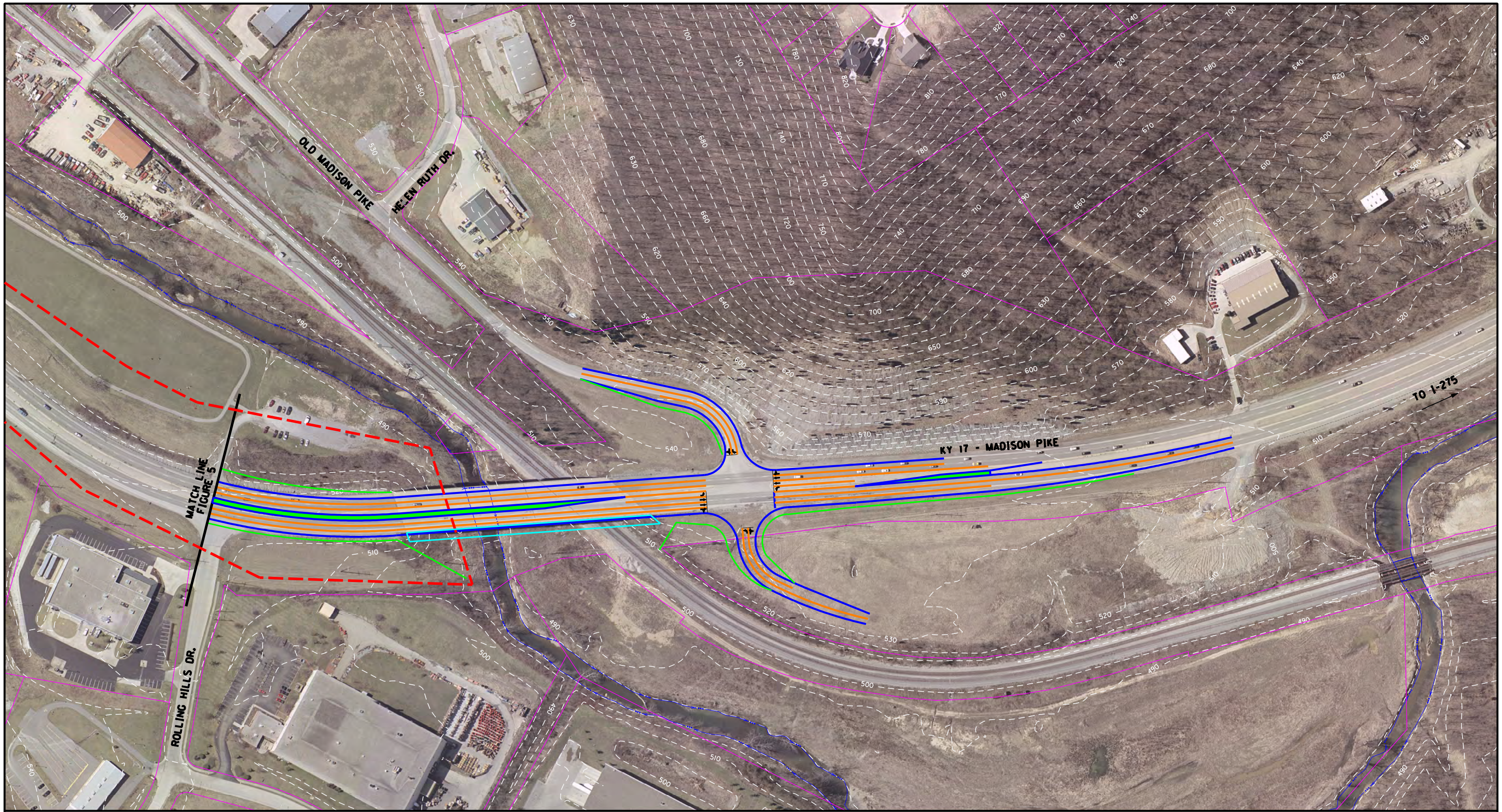

LEGEND



-  PROPOSED LANE MARKINGS
-  PROPOSED EDGE OF PVMT / CURBING
-  PROPOSED EDGE OF DISTURBANCE
-  PROPOSED RETAINING WALL
-  PROPOSED STRUCTURE
-  PROPOSED BIKE PATH
-  EX. CONTOUR
-  PROPERTY LINE

FIGURE 7 – SIGNAL CONCEPT

**KY 17 – MADISON PIKE
@ OLD MADISON PIKE**

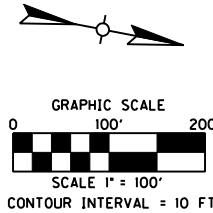

DLZ KENTUCKY, INC.
201 BRIGHTON PARK BLVD.
FRANKFORT, KY 40601
(502) 695-2300 (Fax) 695-1497

accommodate northbound and southbound traffic. The signal alternative would have a reserve capacity of 17 percent (Table 8) during the controlling peak hour (PM).

Safety

This intersection does not currently have a high crash frequency. The installation of modified signal layout at this location with the additional traffic volumes projected would create a similar situation to other signalized intersections within the corridor. Pedestrian and bicycle traffic may be handled in a similar fashion to that discussed for the Holds Branch Road intersection.

Right-of-Way

This alternative would require an additional 1.7 acres of right-of-way. The right-of-way required for this alternative would be taken to construct the access to the property located east of the intersection. No relocations would be required as a result of the signal alternative. No parking will be impacted by the signal alternative. Because this is a planning level cost estimate with many details still unknown, a right-of-way cost estimate was not prepared.

Cost

Planning level cost estimates are in year 2006 dollars and include construction (with bridge widening and water line relocation), and engineering costs. Utility company facilities that are located within the state right of way are the responsibility of the utility company to relocate and have therefore not been estimated. Planning level cost estimates can be found in Appendix E. An additional 15% was included for miscellaneous construction items in order to cover any smaller construction items that have not yet been quantified. Contingency was also added (20%) for material cost fluctuations and unforeseen items. Planning level costs will total \$5,800,000 for this alternative and are as follows:

- Construction – \$4,800,000
- Engineering – \$1,000,000

Operational costs will be minimal and will include periodic maintenance.

Driveways / Access

The signalized alternative would provide access to the property east of the intersection to allow development (currently there is no access). Any new access points between this intersection and Dudley Road could be handled in a variety of ways. The use of $\frac{3}{4}$ intersections (no left turn out) or right in / right out control could be incorporated. However, these options may require median widening to accommodate U-turns and may affect the efficiency of other intersections.

A full access may also be provided to accommodate left turn out traffic. While this option would decrease the need for median widening, it may also create an increased safety concern for motorists wanting to turn left. A full access, depending on the amount of traffic, may also require a traffic signal during peak times, however, traffic operations of this access may be acceptable during off-peak times without a signal. Access for proposed developments near the Dudley Road intersection could also be accommodated by a frontage road with access to Dudley Road rather than Madison Pike.

Any additional access locations between Old Madison Pike and Dudley Road and what type of access to provide will depend on such factors as proximity to adjacent intersections, traffic volumes, land use, etc. Additional access locations have not been analyzed and would be better addressed as part of a separate corridor study. Current business access and visibility will largely remain the same.

Impacts

The signal alternative would have significant impacts to the gas line as well as minor impacts to water and electric facilities. Most of these impacts would occur near the intersection. The bridge to the south of the intersection would also need to be widened to accommodate the additional traffic lanes extending to Holds Branch Road. With the seven required lanes, the bridge would have to be widened by approximately 20 feet and could be widened to one side (east). This widening could be performed by construction of the 20-foot wide section along the entire length of the existing bridge without replacing the existing structure. There are no significant impacts to the hillside located northwest of the intersection with the signal option.

Aesthetics

The signal alternative would result in minimal negative impact on the adjacent area. The additional pavement required for the intersection will reduce existing green space in the adjacent area.

ALTERNATIVE SIGNAL SCHEME

In the late stages of this study, the project team developed an alternative signal scheme at this location. This scheme would use a bypass concept for the northbound through movement (Figure 8). With the help of the Kentucky Transportation Center at the University of Kentucky (KYC at UK), a preliminary analysis indicated that an acceptable level of service could be obtained with this option. The SYNCHRO analysis provided by the KTC at UK estimated that this alternative would operate at LOS A (6.8 second delay) during the AM peak and LOS B (20.0 second delay) during the PM peak hour for the future year conditions. Additional evaluation will be required before implementing this option, including a signal warrant analysis.

With this alternative, the access to the east property would need to be located north of the intersection as the northbound bypass lanes would prohibit a full access at the intersection. In addition, this lane configuration would not require any modifications to the bridge located south of the intersection or to the hillside to the northeast and could be implemented within the existing pavement section.

A southbound right turn lane may be added to improve the efficiency of this option by reconstructing the existing shoulder while avoiding impact to the hillside. This may require a slight shift or decrease in width of the median. Based on preliminary evaluation, this alternative appears to be a viable concept with an estimated planning level cost of \$250,000 and no additional right of way requirements.

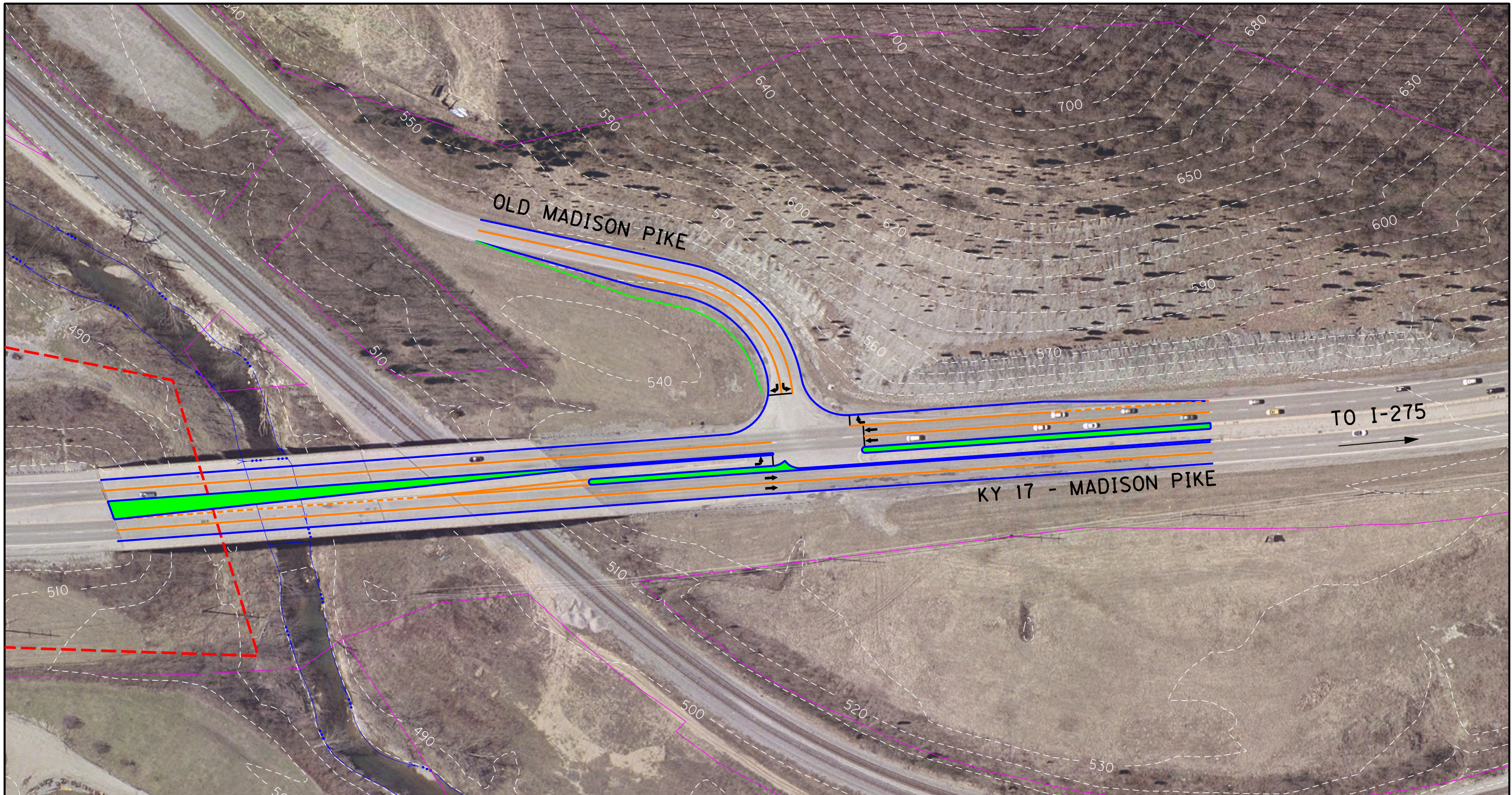

LEGEND

- PROPOSED LANE MARKINGS
- PROPOSED EDGE OF PVMT / CURBING
- PROPOSED EDGE OF DISTURBANCE
- PROPOSED RETAINING WALL
- PROPOSED STRUCTURE
- - - PROPOSED BIKE PATH
- - - EX. CONTOUR
- PROPERTY LINE

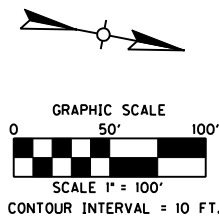

**FIGURE 8 – SIGNAL CONCEPT
WITH NORTH BYPASS LANES**

**KY 17 – MADISON PIKE
@ OLD MADISON PIKE**



ROUNDAABOUT ALTERNATIVE

Geometry

This three-leg roundabout would require two entry lanes on the eastbound approach and three entry lanes on the south and northbound approaches (Figure 9). The northbound approach would require two through bypass lanes. The roundabout would have a diameter of 260 feet.

Traffic Operations

The roundabout intersection is projected to operate at a LOS A for the AM peak hour with an average delay of 2.7 seconds. The roundabout intersection is estimated to operate at LOS B with an average delay of 13.7 seconds during the PM peak hour (Table 7). The roundabout alternative would have a reserve capacity of 6 percent (Table 8) during the PM peak. With roundabouts, once volumes get closer to capacity, delays can increase rapidly, leading to poor LOS. For this reason, it is possible to have a very good LOS (such as A or B) with a low reserve capacity. In this situation, relatively small increases in traffic volumes can result in the intersection having an unacceptable LOS.

Safety

The impacts on safety with the installation of a roundabout at this location are similar to that discussed above for the Holds Branch Road intersection alternative.

Right-of-Way

This alternative would require an additional 1.3 acres of right-of-way. No relocations would be required as a result of the roundabout alternative. No parking will be impacted by the roundabout alternative. Because this is a planning level cost estimate with many details still unknown, a right-of-way cost estimate was not prepared.

Cost

Planning level cost estimates are in year 2006 dollars and include construction (with water line relocation) and engineering costs. Utility company facilities that are located within the state right of way are the responsibility of the utility company to relocate and have therefore not been estimated. An additional 15% was included for miscellaneous construction items in order to cover any smaller construction items that have not yet been quantified. Contingency was also added (20%) for material cost fluctuations and unforeseen items. No bridge widening is required with this alternative. Planning level cost estimates can be found in Appendix E. Planning level costs will total \$5,000,000 for this alternative and are as follows:

- Construction – \$4,200,000
- Engineering – \$800,000

Operational costs will be minimal and will include periodic maintenance.

Driveways / Access

The roundabout alternative would not provide access to the property east of the intersection at the roundabout location. Access to this property would be located to the north of the intersection. This location may allow for access to the west of Madison Pike for future development near Dudley Road and may be handled in a similar fashion as mentioned with

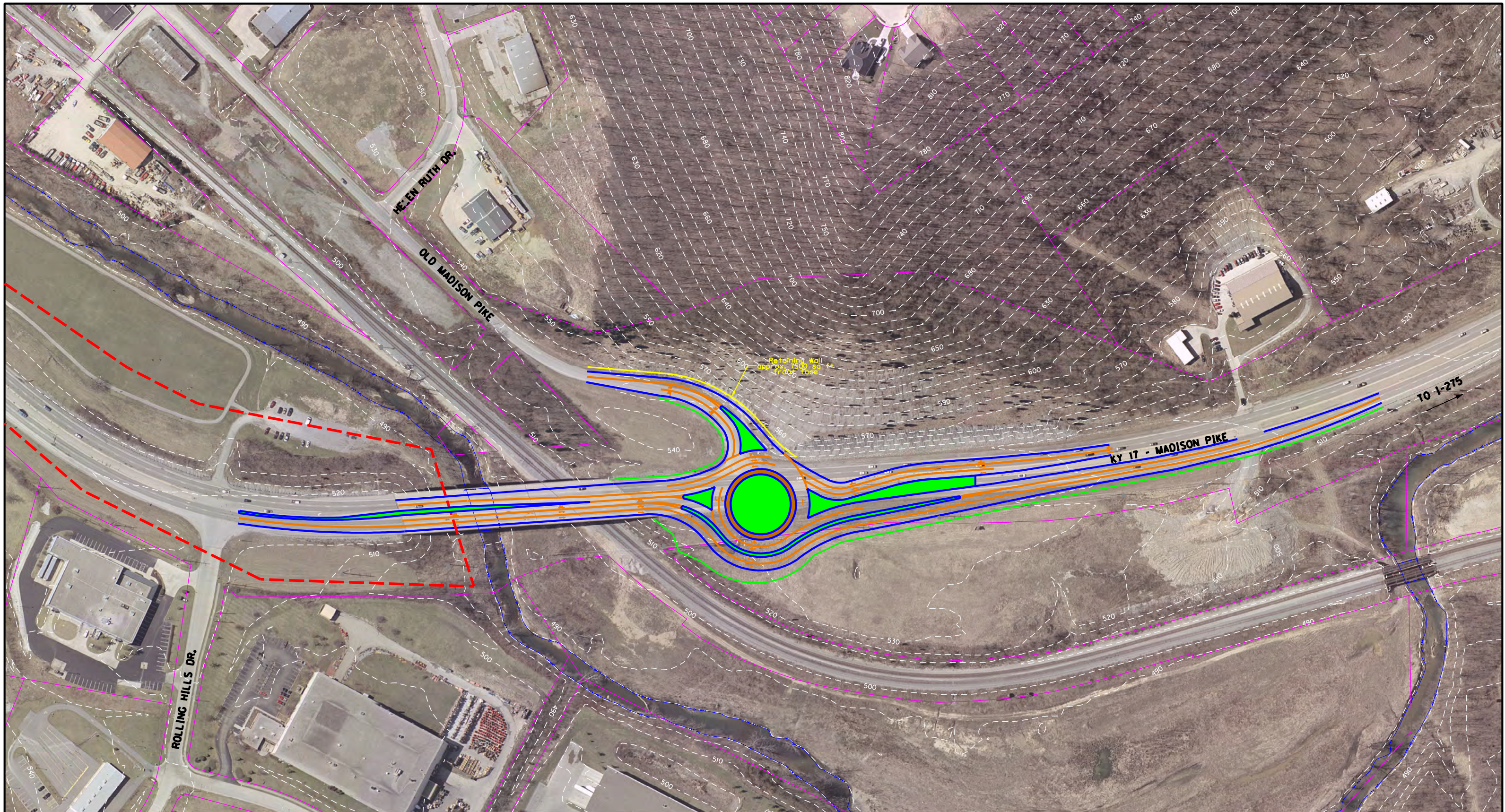

LEGEND









-  PROPOSED LANE MARKINGS
-  PROPOSED EDGE OF PVMT / CURBING
-  PROPOSED EDGE OF DISTURBANCE
-  PROPOSED RETAINING WALL
-  PROPOSED STRUCTURE
-  PROPOSED TRUCK APRON
-  PROPOSED BIKE PATH
-  EX. CONTOUR
-  PROPERTY LINE

FIGURE 9 – ROUNDABOUT CONCEPT

**KY 17 – MADISON PIKE
@ OLD MADISON PIKE**

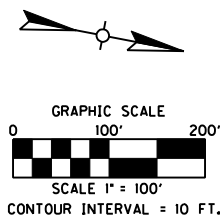

the signal option. However, this would require an additional, more detailed study. Current business access and visibility will largely remain the same.

Impacts

The roundabout alternative would significantly impact existing utilities in the area, including water mains, electric facilities, and gas mains. Most of these impacts would occur along the east side of Madison Pike. The intersection will require a retaining wall (approximately 7500 sq ft – front face) to avoid significant excavation of the hillside to the northwest. This option will not require widening of the bridge located south of the intersection. Construction will cause notable delays and congestion.

Aesthetics

The modern roundabout alternative would provide opportunities for aesthetic enhancement. These opportunities are similar to those mentioned above for the Madison Pike and Holds Branch Road roundabout alternative.

4.1.3 TANK FACILITY / LAKEVIEW DRIVE

SIGNAL ALTERNATIVE

Geometry

The proposed intersection improvement utilizing additional turn lanes is shown in Figure 10. An additional right turn lane was added to the northbound direction and two lanes were used for the eastbound and westbound (TANK entrance) approaches. An access road was added to the west as there is a desire to develop the properties west of the intersection. The continuous left turn (center) lane was also converted to designated left turn lanes for both the northbound and southbound directions. Widening for this option is minimal and occurs only to the east with the addition of the right turn lane.

The signal alternative includes a new approach from the west side of the intersection. Should the new approach to the intersection not be constructed (3-leg intersection), traffic movements from the west would be eliminated improving traffic operations to a level better than predicted. A signal warrant analysis should be conducted for this intersection. All information contained in this section is related to the 4-leg intersection.

Traffic Operations

The improved signalized intersection is projected to operate at LOS C in the year 2030 with an average delay of 30.2 second in the AM Peak Hour. During the PM peak hour the improved signalized intersection is estimated to operate at LOS C with an average delay of 32.8 seconds (Table 7). The majority of the delay from the AM and PM peaks can be attributed to the westbound (TANK entrance) and eastbound (future access) approaches. The westbound approach is estimated to operate at LOS E (58.3 seconds of delay) for the AM peak and LOS D (48.0 seconds of delay) during the PM peak while the eastbound approach is projected to operate at LOS E (60.9 seconds of delay) during the AM peak and LOS D (49.6 seconds of delay) for the PM peak. The signal was timed to accommodate northbound and southbound traffic. The signal alternative would have a reserve capacity of 14 percent (Table 8) during the controlling peak hour (PM).

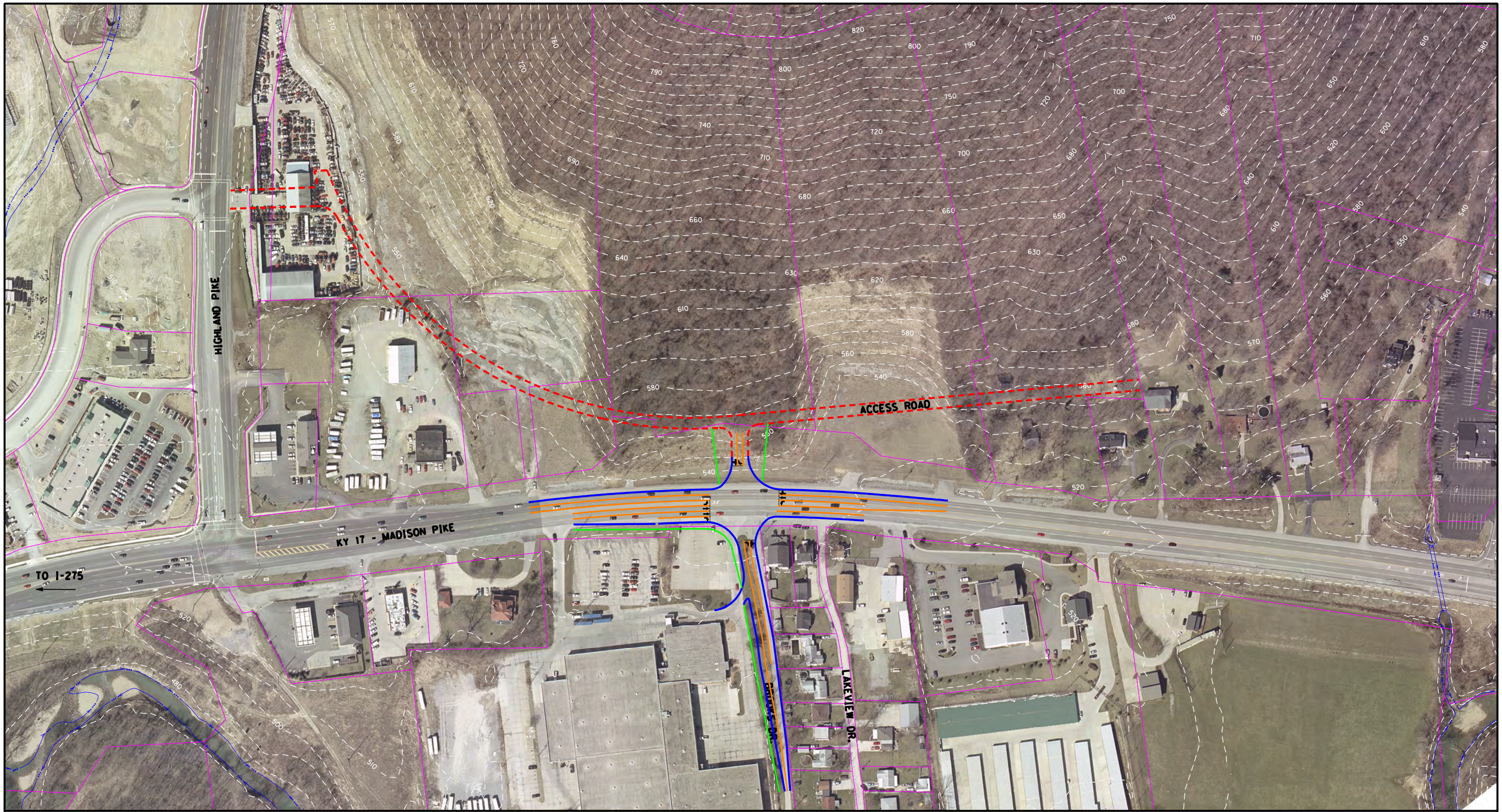

LEGEND









-  PROPOSED LANE MARKINGS
-  PROPOSED EDGE OF PVMT / CURBING
-  PROPOSED EDGE OF DISTURBANCE
-  PROPOSED RETAINING WALL
-  PROPOSED STRUCTURE
-  PROPOSED ACCESS ROAD
-  EX. CONTOUR
-  PROPERTY LINE

FIGURE 10 – SIGNAL CONCEPT

**KY 17 – MADISON PIKE
@ TANK ENTRANCE**



DLZ KENTUCKY, INC.
201 BRIGHTON PARK BLVD.
FRANKFORT, KY 40601
(502) 695-2300 (Fax) 695-1497

Safety

This intersection does not currently have a high crash frequency. The installation of modified signal layout at this location with the additional traffic volumes projected would create a similar situation to other signalized intersections within the corridor. Pedestrian and bicycle traffic may be handled in a similar fashion to what was discussed at the Holds Branch Road intersection.

Right-of-Way

This alternative would require an additional 0.1 acres of right-of-way. No relocations would be required as a result of the signal alternative. No parking will be impacted by the signal alternative. Because this is a planning level cost estimate with many details still unknown, a right-of-way cost estimate was not prepared. The right-of-way impact for this option does not account for land required to connect Lakeview Drive and the TANK Facility Entrance. It is expected that this connection will be made when the TANK expansion occurs.

Cost

Planning level cost estimates are in year 2006 dollars and include construction (with water line relocation) and engineering costs. Utility company facilities that are located within the state right of way are the responsibility of the utility company to relocate and have therefore not been estimated. An additional 15% was included for miscellaneous construction items in order to cover any smaller construction items that have not yet been quantified. Contingency was also added (20%) for material cost fluctuations and unforeseen items. Planning level cost estimates can be found in Appendix E. Planning level costs will total \$1,300,000 for this alternative and are as follows:

- Construction – \$1,100,000
- Engineering – \$200,000

Operational costs will be minimal and will include periodic maintenance.

Driveways / Access

The project team expressed a desire for an access road located west of the intersection. One possible horizontal location of this road with access to Madison Pike is shown in Figure 10. Business access and visibility will change with the addition of the road to the west. If the road does not provide access directly to Madison Pike (west leg of intersection), then access and visibility will remain the same. Also, the TANK Facility Entrance may be enhanced with the improvements in combining the entrance with Brooks Drive. All driveways currently within the project area would be reasonably accommodated.

Impacts

The signal alternative would have minimal to no impacts to existing utilities in the area. Any impacts would occur near the intersection. Allowing adequate distance for an eastbound leg would require that the future access road for the properties to the west be shifted into the hillside. This will create significant impacts due to the construction of the access road.

Aesthetics

The signal alternative would result in minimal negative impact on the adjacent area. The additional pavement required for the intersection will reduce existing green space in the adjacent area.

ROUNDABOUT ALTERNATIVE

Geometry

The Madison Pike and TANK intersection would be constructed as a three-leg roundabout with the possibility of constructing a fourth leg (west) for future development. The roundabout would consist of two lanes on the eastbound and westbound approaches and three entry lanes on the southbound and northbound approaches. Lakeview Drive would be converted into a cul-de-sac, and traffic would be rerouted to Electric Drive, as shown on Figure 11. The roundabout would have a diameter of 250 feet.

The evaluation below includes the impacts of creating a new approach from the west side of the intersection (4-leg intersection). Removal of the west leg would offer some very minor traffic operational benefits (i.e., avg overall delays would go down by 1-2 seconds), but that is inconsequential since it would still be LOS A and we would not be able to reduce the ICD (3 lanes would still be needed NB and SB). The main benefit would be cost since we could avoid the rock cuts, retaining wall, and road construction for that leg. As far as access, there could be a direct drive onto 17 and/or they could use the two adjacent intersections (Highland and Kyle's) if connections were made. Either way, the volumes are low enough that access concerns are probably not substantial.

Traffic Operations

The roundabout intersection is projected to operate at a LOS A for the AM peak hour with an average delay of 5.2 seconds. The roundabout intersection for the PM peak hour is estimated to operate at LOS A with an average delay of 5.8 seconds (Table 7). The roundabout alternative would have a reserve capacity of 23 percent (Table 8) for both the AM and PM peak. With roundabouts, once volumes get closer to capacity, delays can increase rapidly, leading to poor LOS. For this reason, it is possible to have a very good LOS (such as A or B) with a low reserve capacity. As volumes approach the capacity of the roundabout, relatively small increases in traffic volumes can result in the intersection having an unacceptable LOS.

Safety

The impacts on safety with the installation of a roundabout at this location are similar to that discussed for the Holds Branch Road intersection alternative.

Right-of-Way

This alternative would require an additional 1.6 acres of right-of-way. Five relocations (7 buildings) would be required as a result of the roundabout alternative. Two properties situated between Brooks Dr. and Lakeview Dr along Madison Pike, one property at the corner of Lakeview Dr. and Madison Pike (north), and two properties at the end of Brooks Dr. and between Brooks Dr. and Lakeview Dr. will be total takes to accommodate the connection of Lakeview Dr. to Brooks Dr. along with the roundabout and cul-de-sac. No

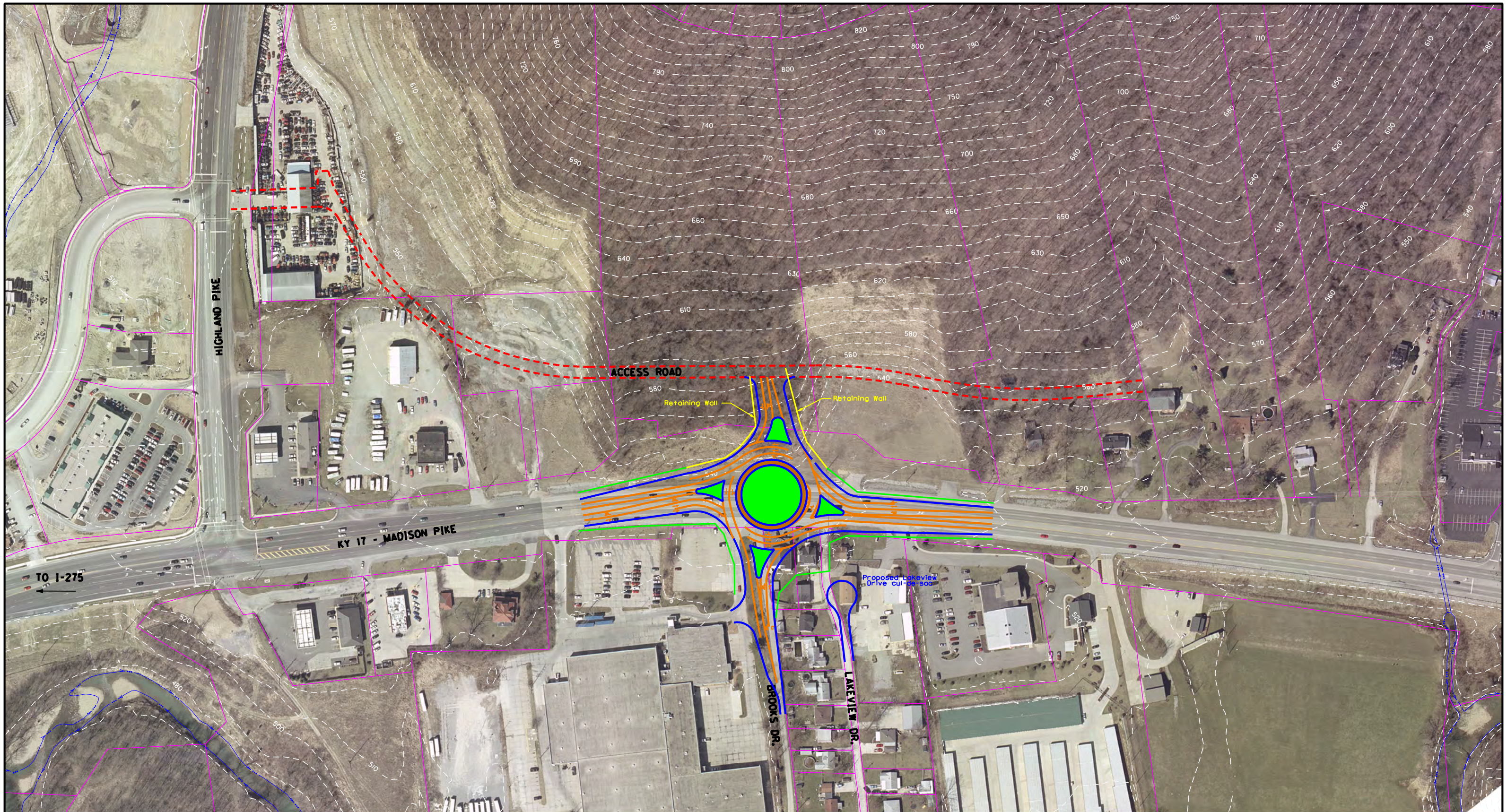









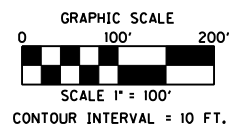
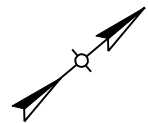

FIGURE 11 – ROUNDABOUT CONCEPT

**KY 17 – MADISON PIKE
@ TANK ENTRANCE**

LEGEND

-  PROPOSED LANE MARKINGS
-  PROPOSED EDGE OF PVMT / CURBING
-  PROPOSED EDGE OF DISTURBANCE
-  PROPOSED RETAINING WALL
-  PROPOSED STRUCTURE
-  PROPOSED TRUCK APRON
-  PROPOSED ACCESS ROAD
-  EX. CONTOUR
-  PROPERTY LINE



DLZ KENTUCKY, INC.
201 BRIGHTON PARK BLVD.
FRANKFORT, KY 40601
(502) 695-2300 (Fax) 695-1497

parking will be impacted by the roundabout alternative. Because this is a planning level cost estimate with many details still unknown, a right-of-way cost estimate was not prepared.

Cost

Planning level cost estimates are in year 2006 dollars and include construction (with water line relocation) and engineering costs. Utility company facilities that are located within the state right of way are the responsibility of the utility company to relocate and have therefore not been estimated. An additional 15% was included for miscellaneous construction items in order to cover any smaller construction items that have not yet been quantified. Contingency was also added (20%) for material cost fluctuations and unforeseen items. Planning level cost estimates can be found in Appendix E. Planning level costs will total \$4,800,000 for this alternative and are as follows:

- Construction – \$4,000,000
- Engineering – \$800,000

Operational costs will be minimal and will include periodic maintenance.

Driveways / Access

One possible horizontal location of the access road to the west as it relates to a roundabout is shown in Figure 10. This location assumes access to Madison Pike. Business access and visibility will change with the addition of the road to the west. If the road does not provide access directly to Madison Pike (west leg of intersection), then access and visibility will remain the same. Also, the TANK Facility Entrance may be enhanced with the improvements in combining the entrance with Brooks Drive. All driveways currently within the project area will be reasonably accommodated.

Impacts

The roundabout alternative would have significant impacts to water mains and gas mains with minor impacts to electric facilities in the area. Most of these impacts would occur along the west side of Madison Pike. Allowing adequate distance for an eastbound leg would require that the future access road for the properties to the west be shifted into the hillside. This will create significant impacts due to the construction of the access road. Construction will cause notable delays and congestion, and access to businesses would be impacted.

Aesthetics

The modern roundabout alternative would provide opportunities for aesthetic enhancement. These opportunities are similar to those mentioned above for the Madison Pike and Holds Branch Road roundabout alternative.

Table 9 Practical Alternatives Matrix –Kentucky 17 Alternatives.

Evaluation Criteria	Comments	KY-17 & Holds Branch Road		KY-17 & Old KY-17		KY-17 & TANK Entrance	
		Roundabout	Signalized Intersection	Roundabout	Signalized Intersection*	Roundabout	Signalized Intersection
Future Traffic Operations	Total delay (Entering volume x Average delay for each intersection) AM and PM peak hours	24 hours AM 20 hours PM	41 hours AM 48 hours PM	4 hour AM 22 hours PM	33 hours AM 33 hours PM	5 hours AM 7 hours PM	32 hours AM 39 hours PM
	Intersection Level of Service (with average delay in seconds)	AM = C (16.8) PM = B (12.6)	AM = C (28.6) PM = C (30.1)	AM = A (2.7) PM = B (13.7)	AM = C (21.4) PM = C (20.3)	AM = A (5.2) PM = A (5.8)	AM = C (30.2) PM = C (32.8)
	Number of approaches operating at LOS E or worse for AM peak hour	1 out of 4	1 out of 4	0 out of 3	2 out of 4	0 out of 4	2 out of 4
	Number of approaches operating at LOS E or worse for PM peak hour	1 out of 4	2 out of 4	0 out of 3	2 out of 4	0 out of 4	0 out of 4
Safety Improvements	Based on existing crash data, crash prediction model and recent U.S. studies.	Significantly safer than signal. Injury crash rate will be about half as high as signal.	Significantly higher injury crash rate than roundabout. Injury crash rate will be about twice as high as roundabout. PDO crashes similar to roundabout.	Significantly safer than signal. Injury crash rate will be about half as high as signal.	Significantly higher injury crash rate than roundabout. Injury crash rate will be about twice as high as roundabout. PDO crashes similar to roundabout.	Significantly safer than signal. Injury crash rate will be about half as high as signal.	Significantly higher injury crash rate than roundabout. Injury crash rate will be about twice as high as roundabout. PDO crashes similar to roundabout.
Right-of-Way Impacts	Approximate acres of new right-of-way required for each alternative as well as number of business and residential relocations for each alternative.	1.1 acres 0 relocations	0.6 acres 0 relocations	1.3 acres 0 relocations	1.7 acres 0 relocations	1.6 acres 5 relocations	0.1 acres 0 relocations
Cost (2006 dollars)	Cost includes Construction and Engineering (design & construction)	TOTAL COST - \$4,100,000 Construction - \$3,400,000 Engineering - \$700,000	TOTAL COST - \$2,500,000 Construction - \$2,100,000 Engineering - \$400,000	TOTAL COST - \$5,000,000 Construction - \$4,200,000 Engineering - \$800,000	TOTAL COST - \$5,800,000 Construction - \$4,800,000 Engineering - \$1,000,000	TOTAL COST - \$4,800,000 Construction - \$4,000,000 Engineering - \$800,000	TOTAL COST - \$1,300,000 Construction - \$1,100,000 Engineering - \$200,000
Reserve Capacity	Amount (%) that 2030 peak hour auto traffic could increase before the intersection would reach LOS E. Assumes a proportional increase of all entering volumes simultaneously.	4% (AM).	15% (PM)	6% (PM)	17% (PM)	23% (AM & PM)	14% (PM)
Accommodation of Driveway Access	Rating of how well the alternative will accommodate existing driveway access. Factors considered include ability to make left turn outs, queue blockage, additional traffic volumes placed along driveway, and driveway relocations.	All driveways reasonably accommodated.	All driveways reasonably accommodated but left turn conflicts will increase as volumes increase.	All driveways reasonably accommodated.	All driveways reasonably accommodated but left turn conflicts will increase as volumes increase.	All driveways reasonably accommodated.	All driveways reasonably accommodated but left turn conflicts will increase as volumes increase.
Truck Access	Factors considered include distance trucks must travel to utilize turnarounds and access to individual businesses.	Slightly better than the signalized alternative since conflicts are less because trucks can use the roundabouts for U-turns to access businesses.	Trucks would have direct access.	Slightly better than the signalized alternative since conflicts are less because trucks can use the roundabouts for U-turns to access businesses. .	Trucks would have direct access.	Slightly better than the signalized alternative since conflicts are less because trucks can use the roundabouts for U-turns to access businesses. .	Trucks would have direct access.

Evaluation Criteria	Comments	KY-17 & Holds Branch Road		KY-17 & Old KY-17		KY-17 & TANK Entrance	
		Roundabout	Signalized Intersection	Roundabout	Signalized Intersection*	Roundabout	Signalized Intersection
Bicyclists and Pedestrians	Rating of the mobility, safety, and impacts on bicyclists and pedestrians of the proposed intersections.	Pedestrians safely accommodated; Bikes safely accommodated as long as they do not use the circulating roadway; Minor concerns related to visually impaired pedestrians.	Pedestrians and bicyclists safely accommodated	Pedestrians safely accommodated; Bikes safely accommodated as long as they do not use the circulating roadway; Minor concerns related to visually impaired pedestrians.	Pedestrians and bicyclists safely accommodated	Pedestrians safely accommodated; Bikes safely accommodated as long as they do not use the circulating roadway; Minor concerns related to visually impaired pedestrians.	Pedestrians and bicyclists safely accommodated
Construction Effects on Traffic	Factors considered include the comparative duration of construction, likely lane closures, and major access restrictions.	Moderate to Major	Moderate to Major	Moderate to Major	Moderate to Major	Moderate to Major	Moderate to Major
Driver Familiarity	Locations where drivers' expectations may not be met	Drivers may be unfamiliar with roundabouts causing some apprehension. Other locations in the U.S. have seen drivers adapt quickly.	Driver expectations met at all locations.	Drivers may be unfamiliar with roundabouts causing some apprehension. Other locations in the U.S. have seen drivers adapt quickly.	Driver expectations met at all locations.	Drivers may be unfamiliar with roundabouts causing some apprehension. Other locations in the U.S. have seen drivers adapt quickly.	Driver expectations met at all locations.
Parking Impacts	Approximate number of parking spaces impacted by the alternative (number and location).	No parking will be impacted.	No parking will be impacted.	No parking will be impacted.	No parking will be impacted.	No parking will be impacted.	No parking will be impacted.
Aesthetics	Factors considered include consistency with community aesthetic goals and the aesthetic opportunities provided by each alternative.	Several opportunities for additional landscaping on central islands and splitter islands.	Minor scenic impacts will result. Limited opportunities for aesthetic enhancements in remaining ROW and an increase in the amount of paved surface.	Several opportunities for additional landscaping on central islands and splitter islands.	Minor scenic impacts will result. Limited opportunities for aesthetic enhancements in remaining ROW and an increase in the amount of paved surface.	Several opportunities for additional landscaping on central islands and splitter islands.	Minor scenic impacts will result. Limited opportunities for aesthetic enhancements in remaining ROW and an increase in the amount of paved surface.
Impacts to Utilities	Type of utility and extent of impact.	Sanitary, Water – significant impact	Water, Electric – minor impacts	Gas, Electric, Water – significant impact	Gas – significant impact Water, Electric – minor impact	Gas, Water – significant impact Electric – minor impact	Minimal to no impacts
Structural Impacts (Culvert / Bridge)	Approximate new culvert length needed for each alternative.	50' culvert extension with 120' channel change along Tributary. Retaining Wall (4000 sq ft) required to avoid impact to Banklick Creek.	Minimal to no impacts	No impacts to bridge or stream.	Bridge widening (20') required. Approximately 11,000 sq ft of top deck.	N/A	N/A
Impacts to Hillside	Degree of impact to surrounding topography (steep hillsides adjacent to Madison Pike)	N/A	N/A	Retaining Wall (7500 sq ft) required to minimize impacts to hillside.	The hillside will not be impacted	Addition of Access Road will create significant impacts to the hillside. Approximate 40' cut.	Addition of Access Road will create significant impacts to the hillside. Approximate 35' cut.
Operational Cost	Cost of ongoing operations including electricity (lighting), signal adjustment, bulbs/other equipment, mowing, pavement markings, etc.	Low	Low-Moderate	Low	Low-Moderate	Low	Low-Moderate

* Refer to section 4.1.2 for more information regarding a variation on the signal option.

SECTION 5 – RECOMMENDATIONS

5.0 INTRODUCTION

The following technical recommendations are based on the factors and criteria discussed earlier in this report and include consideration of traffic operations, cost, ROW impacts, safety, and other factors. The Practical Alternatives matrix shown previously in Table 9 was used in preparing the recommendations.

5.1 GENERAL RECOMMENDATIONS

During the course of this study, it became evident to members of the study team that the three intersections which were the focus of this study are inextricably linked to the overall Madison Pike corridor from Holds Branch Road on the south to Kyle's Lane on the north. As a result, the project team expressed a clear and unanimous desire to evaluate the operation and interaction of all intersections and major access points in the corridor. Therefore, it is recommended that these issues be addressed through joint study, planning, and site plan reviews among local authorities and KYTC. An overall corridor study is recommended to identify specific road improvements and access management measures for the entire corridor, taking into account relevant interaction and connectivity. It is important that all of the intersection-specific recommendations provided in sections 5.2, 5.3, and 5.4 be revisited as part of the corridor study to assure that they make sense in the context of the overall solution that is ultimately selected.

Recommendations that could be implemented prior to the overall corridor study are included for each of the three study intersections. It is recommended that decisions be made soon regarding measures to be implemented at each intersection and that these be added to OKI's unscheduled project list so that funding can be sought.

Decisions need to be made soon..... so that funding can be sought.

The topic of access management is very important in the Madison Pike Corridor. This study only evaluated access points directly influencing or affected by the three study intersections. The use of $\frac{3}{4}$ intersections (no left turn out) or right in / right out control could be utilized at most or all of these access points. However, these options may require median widening to accommodate U-turns and may affect the efficiency of other intersections. Access for proposed developments may also be accommodated using a frontage road with limited access locations to Madison Pike. In addition, common access management procedures such as combined drives, joint driveway permit reviews, etc. are recommended.

5.2 HOLDS BRANCH ROAD / PIONEER PARK

The existing intersection performs marginally with LOS D in the AM peak hour for 2006 traffic conditions. The future traffic conditions in 2030 are predicted to be LOS F for AM and PM peak hour conditions.

Traffic operations for both alternatives would be similar. However, the estimated cost and right of way for the signal alternative provides a more realistic long term solution. In the short term, local authorities (planning and zoning) and KYTC should add turn lanes to accommodate the additional traffic volumes if funds are not available for the recommended intersection improvement. It is possible that developers fund these improvements as part of their site plan approvals. In the short term, two turn lanes could be added: 1) westbound right turn lane on Holds Branch Road and 2) an additional left turn lane along southbound Madison Pike into Holds Branch Road. The additional left turn lane may be constructed within existing right of way, however, this lane should not be added until absolutely necessary because a protected left turn phase would be required, and this would affect off-peak delays.

Developers fund improvements as part of site plan approvals

5.3 OLD MADISON PIKE

The Madison Pike and Old Madison Pike intersection has an unacceptable LOS F for AM and PM traffic operations for 2006 and 2030. The signal alternative with additional lanes and the roundabout alternative both provide for acceptable traffic operations, however, both appear to be non-cost effective requiring significant impacts to the bridge and the hillside respectively.

The recommended alternative is the altered signal scheme that utilizes two northbound bypass lanes on Madison Pike (Figure 8). Traffic operations for this alternative perform at an acceptable level of service for future traffic volumes at this intersection. This alternative will cost an estimated \$250,000 without any impact to the bridge located south or to the hillside located northwest of the intersection. This recommendation will require that any access to the east property be located north of the intersection.

Any new access points between this intersection and Dudley Road could be handled in a variety of ways. The use of $\frac{3}{4}$ intersections (no left turn out) or right in / right out control could be incorporated. However, these options may require median widening to accommodate U-turns and may affect the efficiency of other intersections. A full access may also be provided to accommodate left turn out traffic. While this option would decrease the need for median widening, it may also create an increased safety concern for motorists wanting to turn left. A full access, depending on the amount of traffic, may also require a traffic signal during peak times. Access for proposed developments near the Dudley Road intersection could also be accommodated by a frontage road with access to Dudley Road rather than Madison Pike. A recommendation for additional access type and location between Old Madison Pike and Dudley Road has not been provided. Off-peak traffic operations of any access (including full access) may be acceptable without a signal depending on such factors as proximity to adjacent intersections, traffic volumes, land use, and site specific factors (based on developer intentions) that are not known at this time.

5.4 TANK FACILITY / LAKEVIEW DRIVE

The TANK facility is currently operating at a LOS D in the AM peak and LOS E in the PM peak for 2006 traffic conditions. The No Build scenario (with installation of a traffic signal) estimates that the intersection will operate at LOS D in the AM peak and LOS E in the PM peak in the year 2030. Through project team discussions, this would be an acceptable level of service and therefore, is the recommended alternate. The No Build alternative involves installing a traffic signal with no lane widening for through or turn movements. The existing continuous left turn lane should be striped for a designated left turn lane on either side of the intersection. A Traffic Signal Warrant Analysis will need to be performed prior to the installation of a traffic signal to determine whether the intersection meets KYTC criteria for a traffic signal. We recommend creating a cul-de-sac on Lakeview Drive and improving Brooks Drive and the TANK Facility Entrance, creating one access point to Madison Pike. The connection of Lakeview Drive to the TANK Facility Entrance could occur in conjunction with TANK Facility Expansion plans.

Installing a traffic signal with no lane widening...

Access management will be important as the properties north of the intersection redevelop. New access for developments in this location may be handled with the use of a frontage or rear access road that connects to the TANK facility entrance. Full access points directly onto Madison Pike should be limited, however, they may be created as right in / right out access or shared access with other developments in the area. Right in / right out control will require U-turn locations at nearby intersections requiring a wider median and may lower the traffic operations at these intersections.

5.5 OTHER RECOMMENDATIONS

The *Madison Pike Corridor Land Use and Economic Development Plan* recommended further evaluation of a non-traversable median along the corridor. This was considered for both the signal and roundabout options. The use of non-traversable medians throughout the corridor is likely to improve or at least maintain existing operational efficiency. The non-traversable median would require right in – right out access at driveways where the non-traversable median is present. Median cuts may be incorporated at designated locations to allow left turn movements and U-turns. The location of these openings will depend on the density of businesses as well as maintaining adequate storage for anticipated queue lengths. U-turns for larger vehicles will require a wider median in order for the vehicle to complete the u-turn movement. The specifics of this median should be identified as part of the overall corridor study since this measure has implications beyond the three intersections included in the current study.

Indirect or “Michigan” left turns are another option for access management and can also provide a significant increase in intersection capacity. This type of facility typically requires the use of a median 50 to 80 feet wide in order to facilitate left and u-turns, especially if trucks are involved. This treatment is not desirable at the three study intersections due to constraints such as Banklick Creek, adjacent development, the railroad, and steep hillsides adjacent to Madison Pike. All of these conflicts would result in substantial cost increases.

Based on DLZ's recommendations, the project team decided not to evaluate this option as part of this study. However, if a larger corridor study is eventually conducted, this option should be considered since it could be cost effective relative to other corridor-level solutions.

SECTION 6 – REFERENCES

American Association of State Highway and Transportation Officials, “A Policy of Geometric Design of Highways and Streets,” Washington D.C., 2004.

Federal Highway Administration, “Roundabouts: An Informational Guide,” Washington D.C.: United States Department of Transportation, 2000.

Ourston Roundabout Engineering, “Roundabout Design Guidelines,” 2001.

Transportation Research Board, “Highway Capacity Manual, 2000.

Northern Kentucky Area Planning Commission, “Corridor Land Use and Economic Development Plan,” 2005.

Institute of Transportation Engineers, “Trip Generation Handbook, Second Edition,” June 2004.

Lalani, N., “The impact on accidents of the introduction of mini, small, and large roundabouts at major/minor priority junctions,” Traffic Engineering and Control, London, United Kingdom, 1975.

MADISON PIKE (KY 17) ROUNDABOUT FEASIBILITY STUDY
NKAPC
Fort Wright / Covington, Kentucky

APPENDIX A

Kenton County Traffic Forecast Madison Pike (KY 17) Roundabout Evaluation Study



**Division of Planning
June 9, 2006**

Table of Contents

Executive Summary
Vicinity Map
Summary Map
Turning Movements
Future Developments

Traffic Forecast

Executive Summary

PROJECT DESCRIPTION

The purpose of this project is to analyze traffic for a modern roundabout evaluation study along Madison Pike (KY 17) in Kenton County. The roundabouts to be analyzed are along the KY 17 corridor at the intersections with Holds Branch Road, KY 3148 (Old KY 17), and the North TANK Bus Station Entrance combined with Electric Drive and Lakeview Drive. This forecast provides traffic estimates at these locations.

TYPE of FORECASTS

The following types of forecasts were developed:

- Average Daily Traffic (ADT) projections were developed for the analysis years 2006 and 2030 for the No-Build, Build scenario.
- 2006 and 2030 ADT and DHV turning movement forecasts were provided for 3 intersections along the corridor; KY 17 & Holds Branch Road, KY 17 & KY 3148 (Old KY 17), and KY 17 & Bus Entrance + Electric Drive + Lakeview Drive.
- Truck percentage estimates were provided for 2030.

TRAFFIC VOLUMES / GROWTH RATES

Current year 2006 volumes were based on historical counts in Kenton County and special counts performed in January 2006. Special turn movement counts were extrapolated to determine current year volumes for various project segments. The Northern Kentucky MPO (OKI) provided model runs for the current and future year. Future development information was gathered from the Northern Kentucky Area Planning Commission, DLZ Kentucky, Inc., and CDS Associates, Inc. along the corridor and side streets. ITE trip generation rates were applied to planned future development to estimate future traffic (for more information see attached development information at the end of the report). The data from the model, future development, and growth rate analysis were used to determine 2030 volumes.

DESIGN HOUR VOLUMES

Design Hour Volumes for the turning movements were determined directly from the special turn movement counts. The maximum maneuvers from the 2-hour AM count and the 2-hour PM count were used to develop a daily AM and PM DHV. A monthly factor was applied to normalize the counts to an average daily max. A K-factor factor was then applied to estimate the yearly DHV (30th highest hour of the year). The future year DHVs were cut off at an estimated capacity (using modified NCHRP 387 equations) of 1700 vehicles per lane in any direction on KY 17. The signal at Dudley Road and KY 17 would further constrain southbound volumes on KY 17 in the peak hour. It was determined the capacity should be 1450 vehicles per lane for the southbound KY 17 movements south of Dudley Road. KY 17 currently has two lanes in each direction so the maximum northbound total volume for the Design Hour was determined to be 3400. The maximum southbound total volume on KY 17 south of Dudley Road for the Design Hour was determined to be 2900. Capacity was not an issue for the intersection analyzed north of Dudley Road. It was determined that the K-factor would flatten out to 10% in the future, but this capacity restraint also constrained the ADT projections. AM and PM DHV directional factors were determined from the max maneuvers of the AM and PM special turning movement counts.

TURNING MOVEMENTS

Three turning movements were analyzed for the project. These turning movements were developed from the volume and DHV methods mentioned above. Also special turning movement counts were made and grown to reflect ADT turning movements. AM and PM Design Hour turn movements were based on the max turn maneuvers from the manual turn movement counts. These numbers were grown to reflect the DHV totals mentioned above.

TRUCK PERCENTAGES

Special counts were performed from 9AM to 1PM in January 2006 to determine truck percentages on KY 17. Factors were applied to estimate 24-hour classification data from other classification counts performed on the same functional class roadway. Research from across the state indicates a 1.5% growth rate be used for truck percentages. This factor was applied to forecast the 2030 projections.

Division of Planning
Kenton County: Madison Pike (KY 17) Roundabout Evaluation Study
Traffic Forecast Vicinity Map

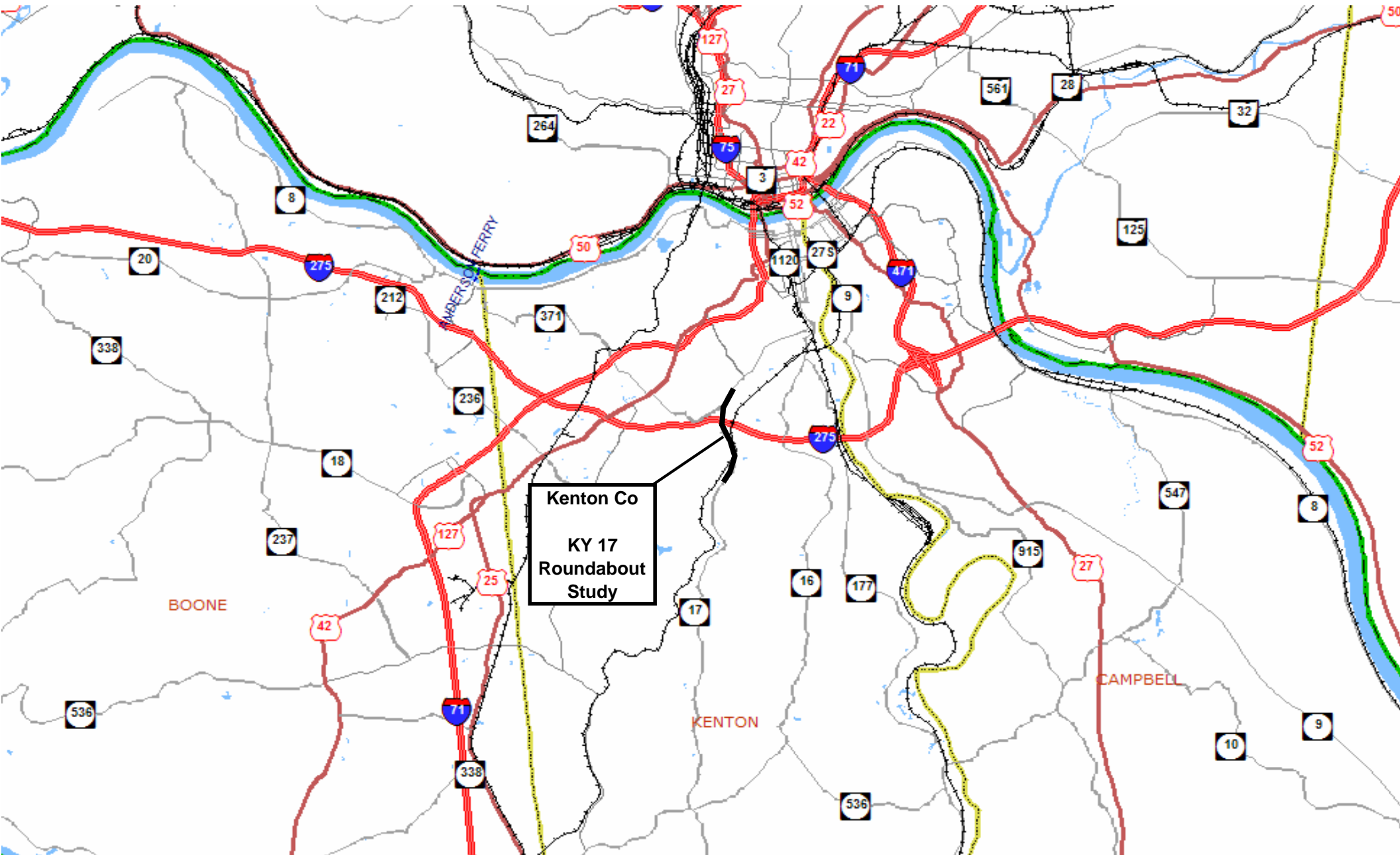

Division of Planning

Kenton County: Madison Pike (KY 17) Roundabout Evaluation Study

Traffic Forecast Summary Map

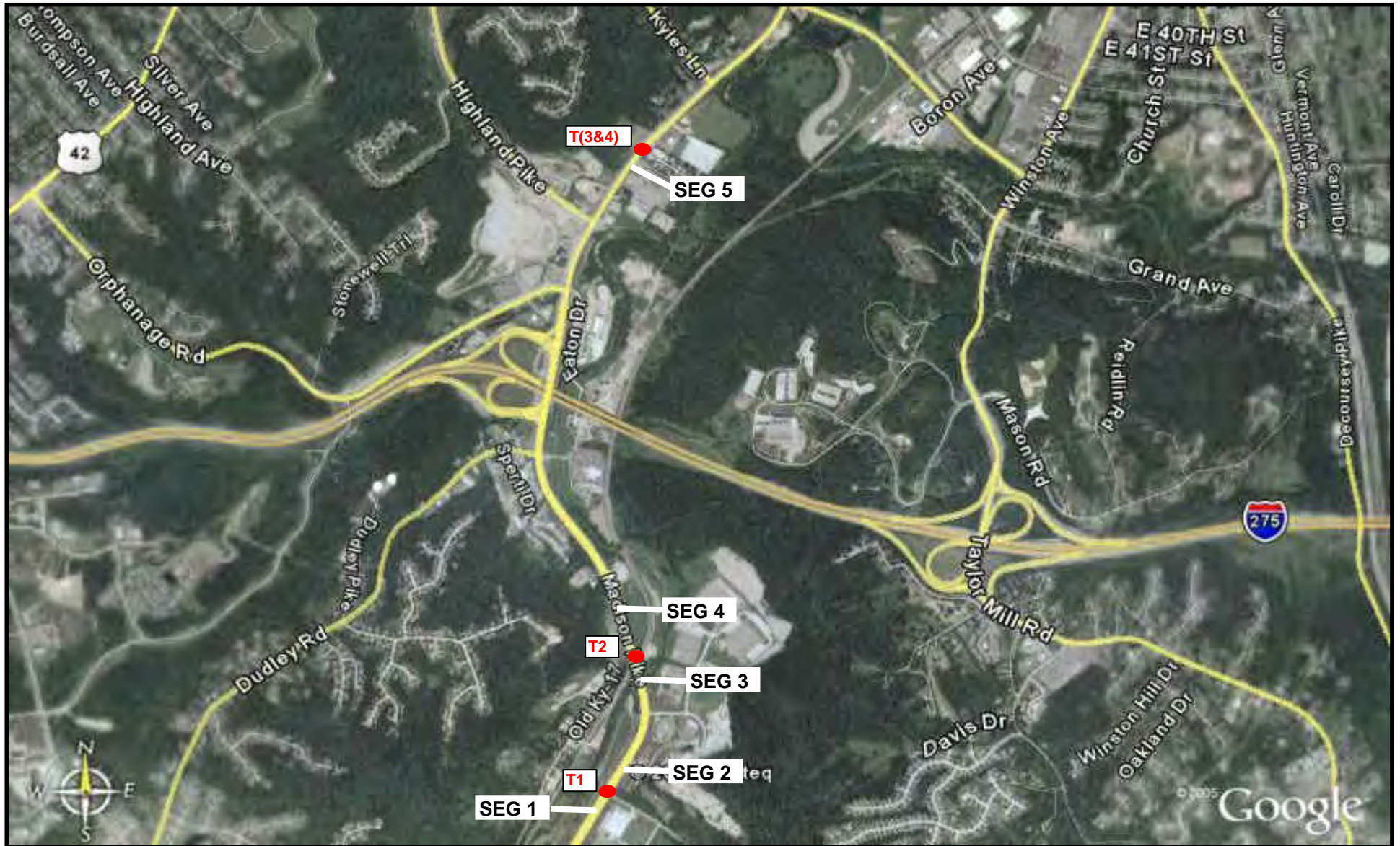

Segment	Route	Milepoint	2006 ADT	2030 ADT	2030 DHV	2030 T% (ADT)	2030 T% (DHV)	2030 Heavy T% (ADT)
1	KY 17	17.1	29,600	47,000	4,700	7.0%	6.0%	1.0%
2	KY 17	17.4	30,000	53,000	5,300	7.0%	6.0%	1.0%
3	KY 17	16.0	35,700	53,000	5,300	9.0%	8.0%	3.0%
4	KY 17	16.2	36,500	55,000	5,500	9.0%	8.0%	3.0%
5	KY 17	19.2	22,000	33,000	3,600	10.0%	8.0%	2.0%

TURNING MOVEMENTS

2006 and 2030 ADT and DHVs (Build, No-Build)

T1: KY 17 (Madison Pike) & Holds Branch Road

T2: KY 17 (Madison Pike) & KY 3148 (Old KY 17)

T4: KY 17 (Madison Pike) & North TANK Bus Station Entrance Combined with Electric Drive and Lakeview Drive / New Development from West of Intersection for 2030

PROJECT: Kenton Co, KY 17 Roundabout Study
 ITEM NUMBER:
 MARS NUMBER: 7793519P
 REQUEST DATE: 1/10/2006
 ANALYST: D. Hamilton
 SCENARIO: **2006 ADT and Design Hour Volumes**
 INTERSECTION: KY 17 & Holds Branch Road

NOTE: K-Factors, Directional Distributions, and Peak Hour Factors were determined from a 2006 Turning Movement Count

Peak Hour Factors		AM		PM		Thru		Right		Left	
		AM	PM	AM	PM	AM	PM	AM	PM	AM	PM
↓	Southbound	0.96	0.94	0.94	0.94	--	--	0.79	0.63		
↑	Northbound	0.96	0.94	0.94	0.94	0.56	0.63	--	--		
←	Westbound	0.60	0.73	--	--	0.65	0.83	0.34	0.70		

* Arrows indicate approach direction, PHF given by approach and approach movement

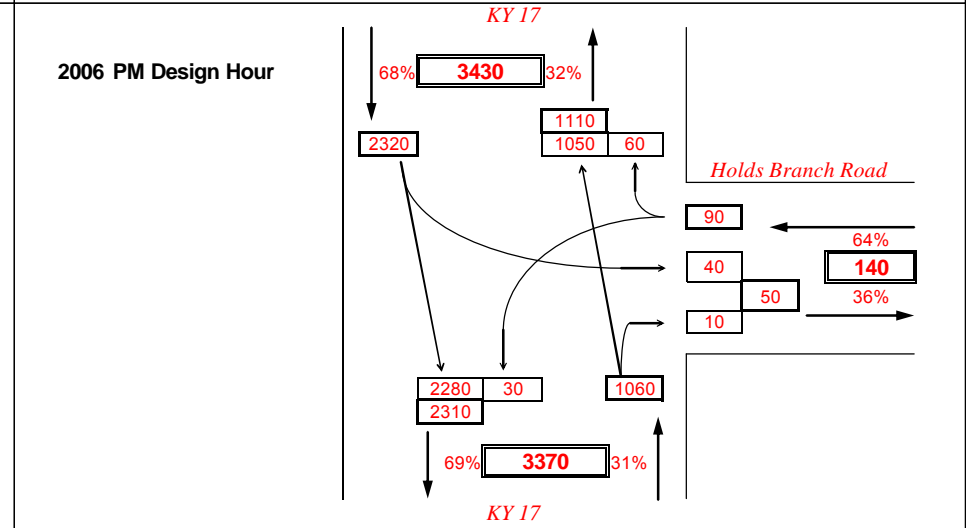
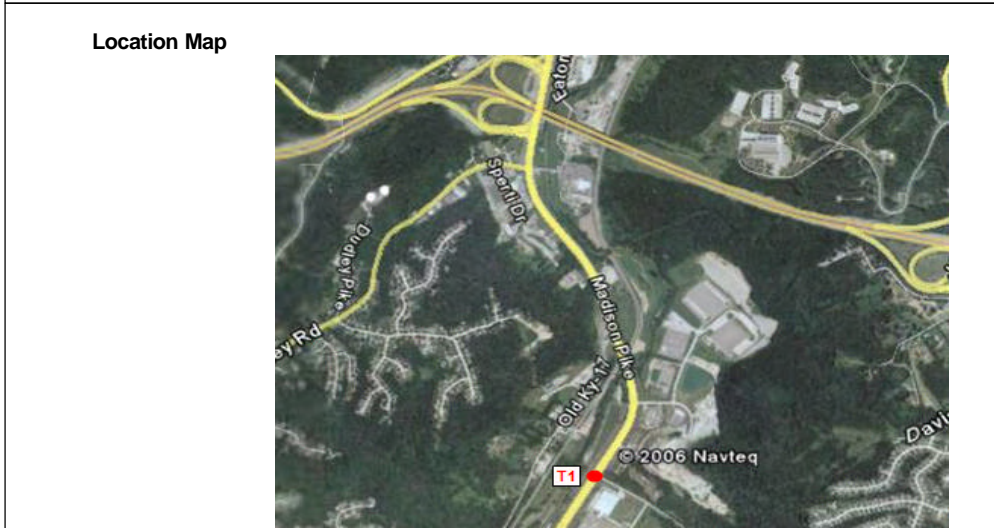
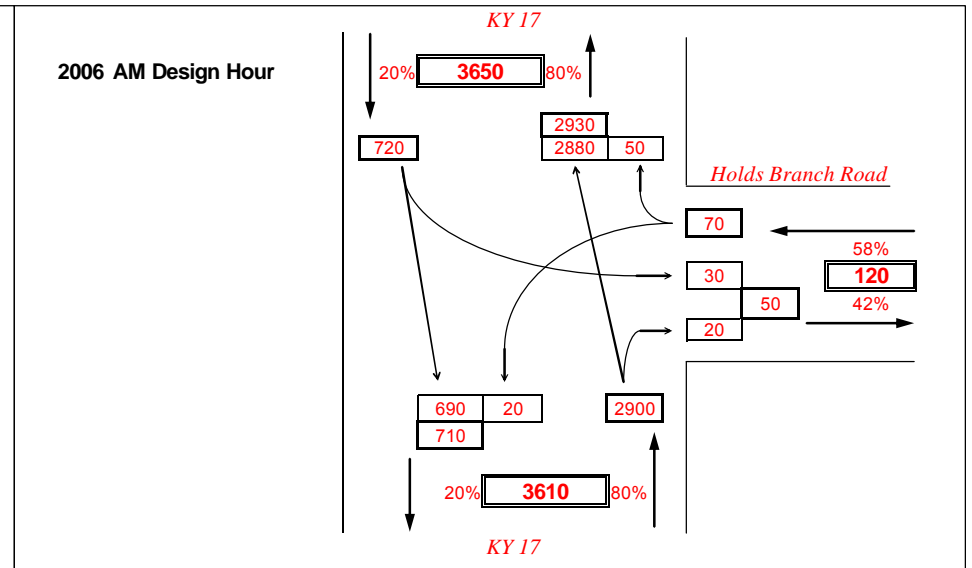
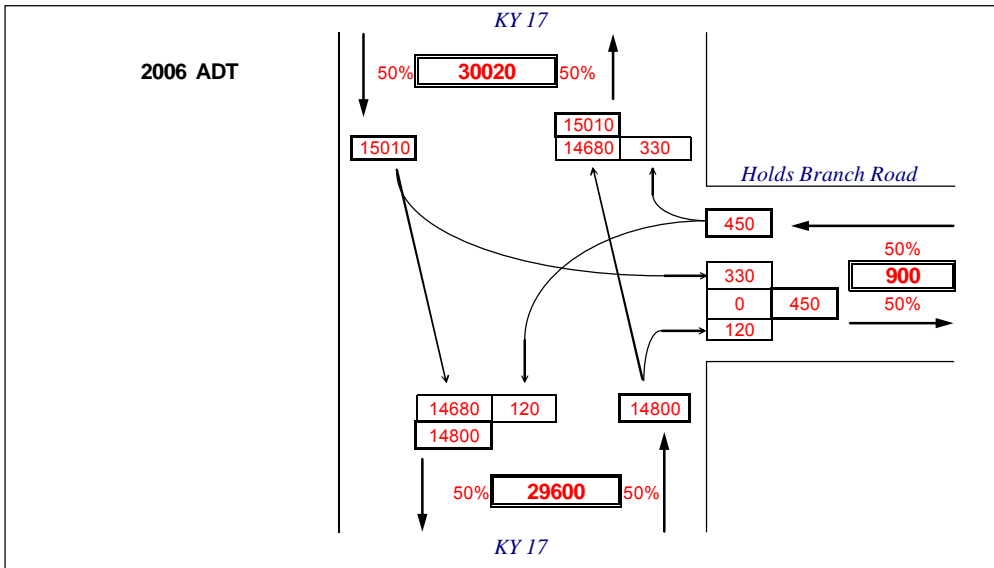

PROJECT: Kenton Co, KY 17 Roundabout Study
 ITEM NUMBER: 0
 MARS NUMBER: 7793519P
 REQUEST DATE: 1/10/2006
 ANALYST: D. Hamilton
 SCENARIO: 2030 ADT and Design Hour Volumes
 INTERSECTION: KY 17 & Holds Branch Road

NOTE: K-Factors and Directional Distributions were determined from 2006 traffic counts

Assumes KY 17 remains a four lane road and the peak hour capacity is 1700 veh per lane in the Northbound direction and 1450 veh per lane in the Southbound direction

Assumes proposed planned developments on Holds Branch Road are built

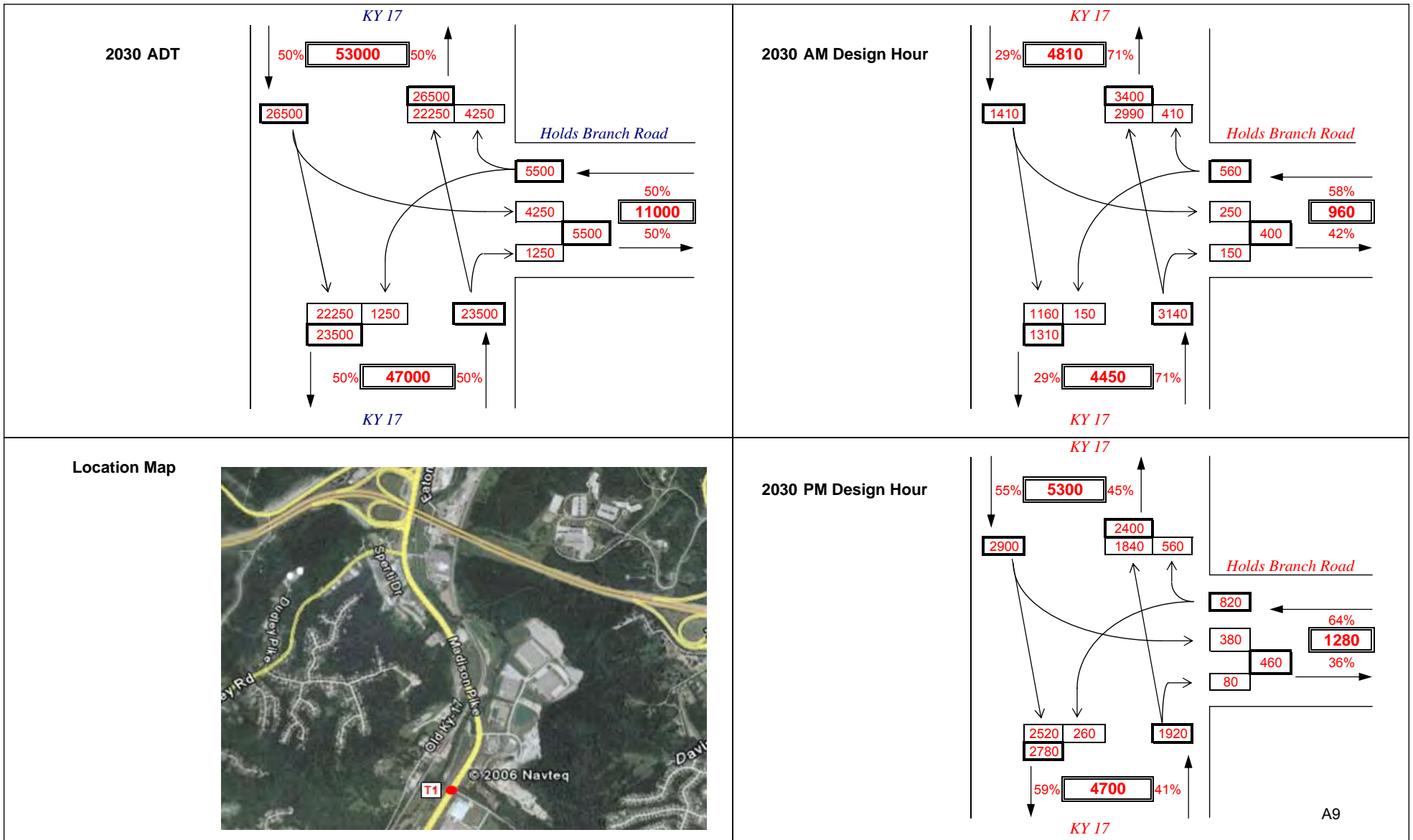

PROJECT: Kenton Co, KY 17 Roundabout Study
 ITEM NUMBER: 7793519P
 MARS NUMBER: 7793519P
 REQUEST DATE: 1/10/2006
 ANALYST: D. Hamilton
 SCENARIO: **2006 ADT and Design Hour Volumes**
 INTERSECTION: KY 17 & KY 3148 (Old KY 17)

NOTE: K-Factors, Directional Distributions, and Peak Hour Factors were determined from a 2006 Turning Movement Count

Peak Hour Factors		AM		PM		Thru		Right		Left	
		AM	PM	AM	PM	AM	PM	AM	PM	AM	PM
↓	Southbound	0.95	0.98	0.87	0.90	0.85	0.85	--	--	--	--
↑	Northbound	0.95	0.98	0.97	0.88	--	--	0.42	0.63	--	--
→	Eastbound	0.81	0.84	--	--	0.60	0.67	0.67	0.61	--	--

* Arrows indicate approach direction, PHF given by approach and approach movement

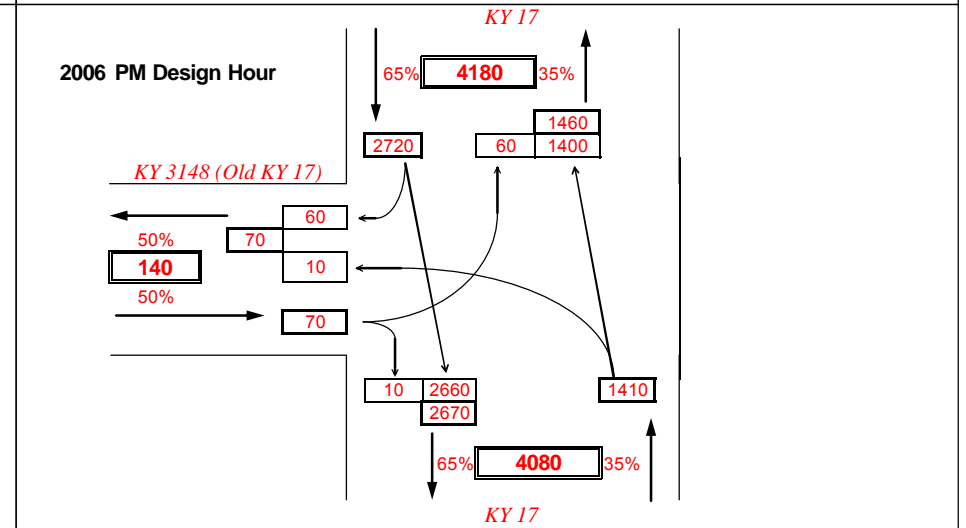
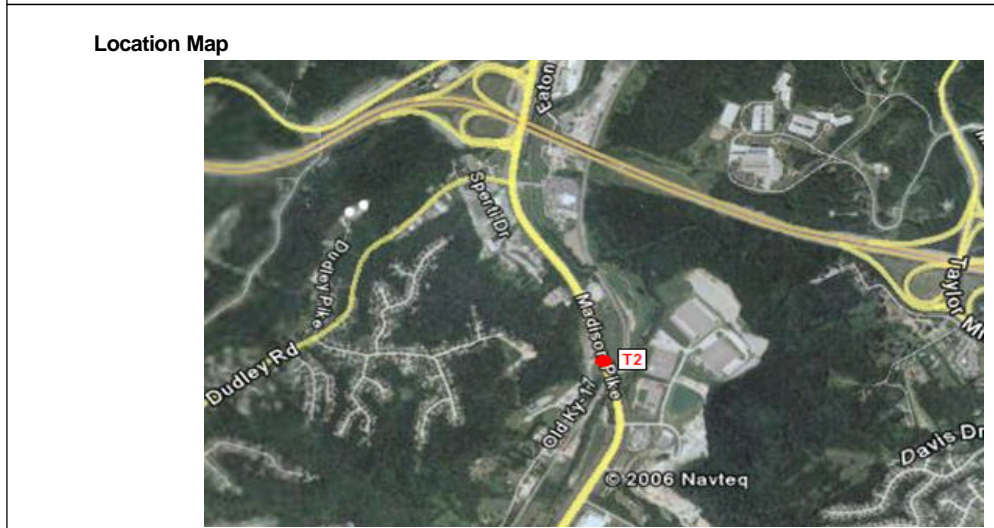
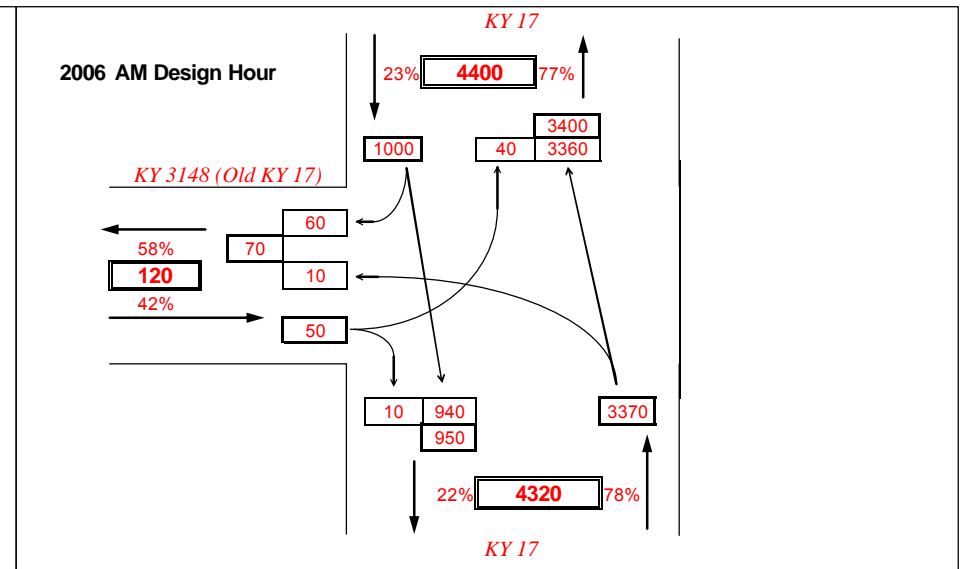
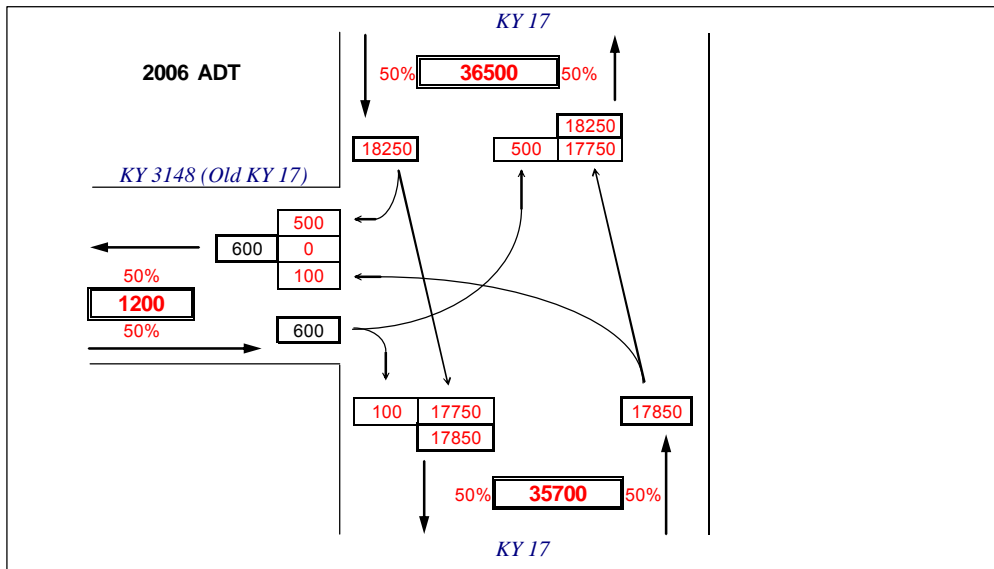

PROJECT: Kenton Co, KY 17 Roundabout Study
 ITEM NUMBER: 0
 MARS NUMBER: 7793519P
 REQUEST DATE 1/10/2006
 ANALYST: D. Hamilton
 SCENARIO: 2030 ADT and Design Hour Volumes
 INTERSECTION: KY 17 & KY 3148 (Old KY 17)

NOTE: K-Factors and Directional Distributions were determined from 2006 traffic counts

Assumes KY 17 remains a four lane road and the peak hour capacity is 1700 veh per lane in the Northbound direction and 1450 veh per lane in the Southbound direction

Assumes proposed planned developments on KY 3148 are built

Assumes proposed planned developments on new entrance are built

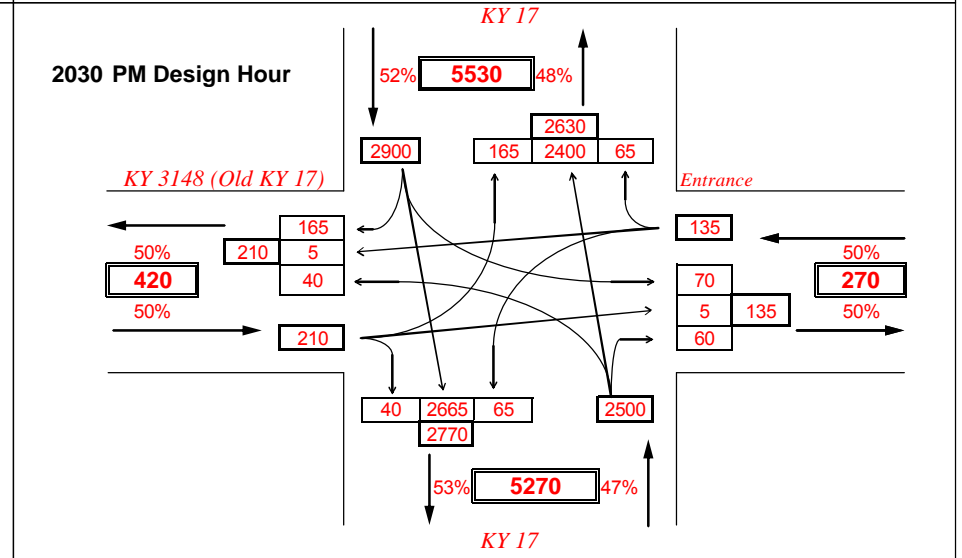
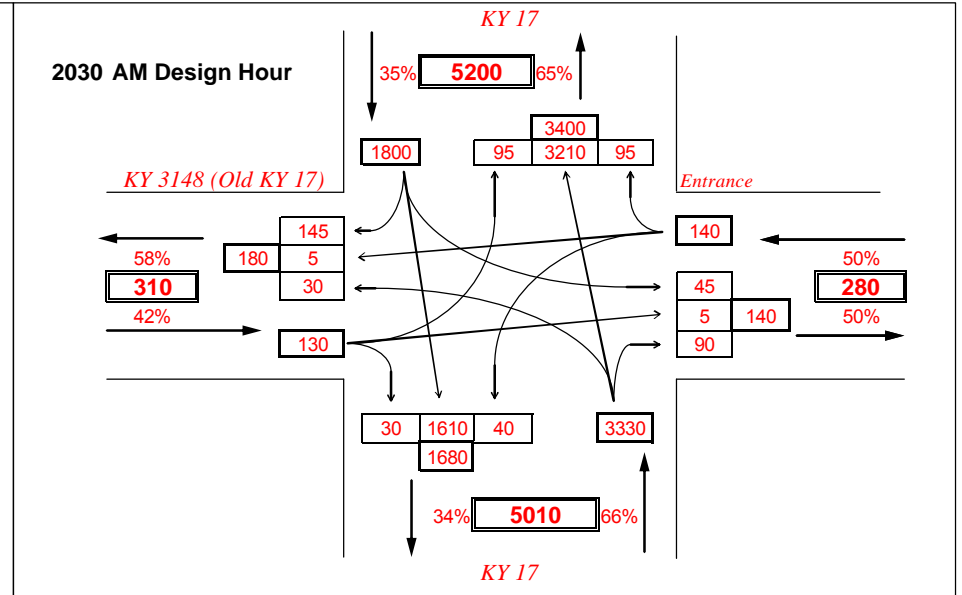
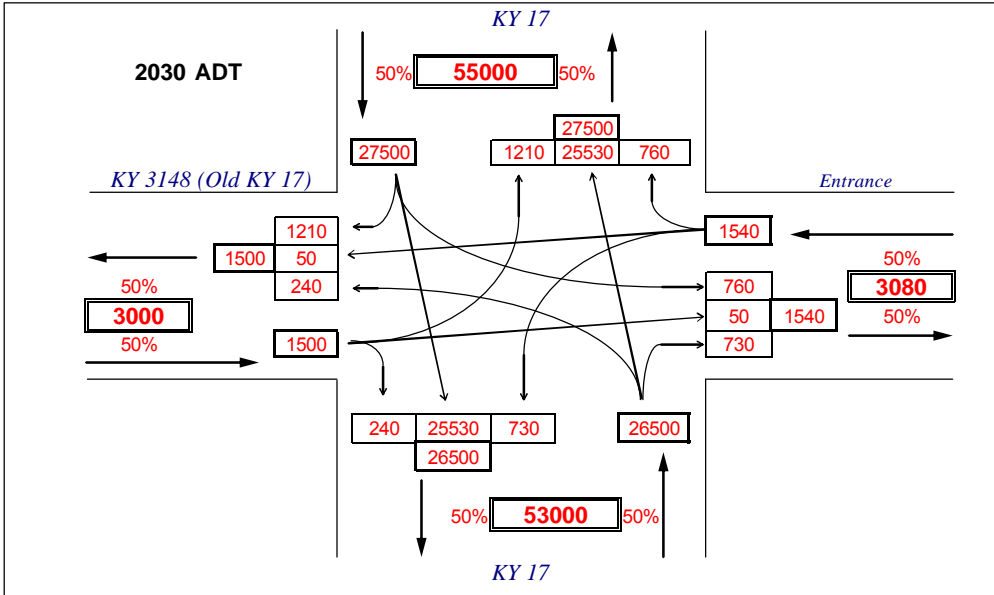

PROJECT: Kenton Co, KY 17 Roundabout Study
 ITEM NUMBER:
 MARS NUMBER: 7793519P
 REQUEST DATE: 1/10/2006
 ANALYST: D. Hamilton
 SCENARIO: **2006 ADT and Design Hour Volumes**
 INTERSECTION: KY 17 & Bus Station + Electric Dr + Lakeview Dr

NOTE: K-Factors, Directional Distributions, and Peak Hour Factors were determined from a 2006 Turning Movement Count

Peak Hour Factors	AM		PM		Thru		Right		Left	
	AM	PM	AM	PM	AM	PM	AM	PM	AM	PM
Southbound	0.85	0.93	0.83	0.90	--	--	0.65	0.55		
Northbound	0.85	0.94	0.80	0.96	0.81	0.64	--	--		
Westbound	0.82	0.82	--	--	0.31	0.68	0.67	0.54		

* Arrows indicate approach direction, PHF given by approach and approach movement

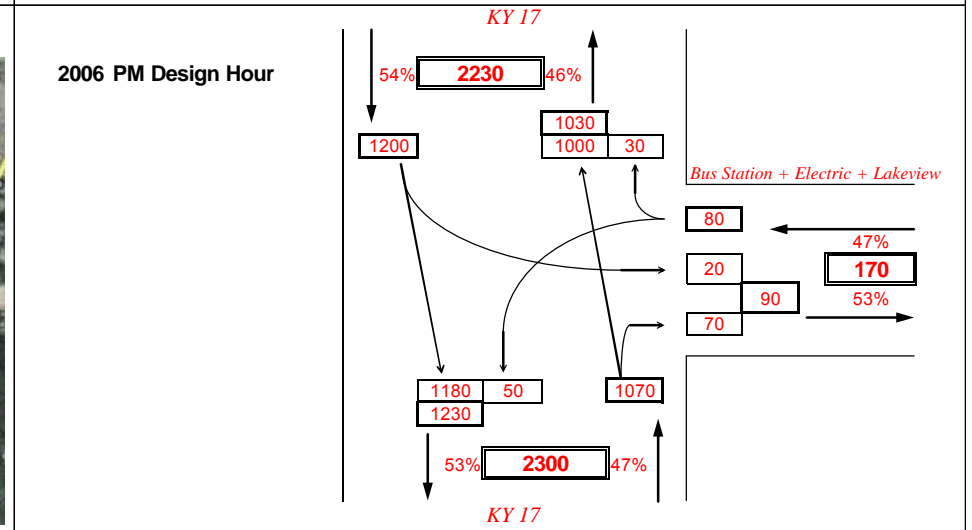
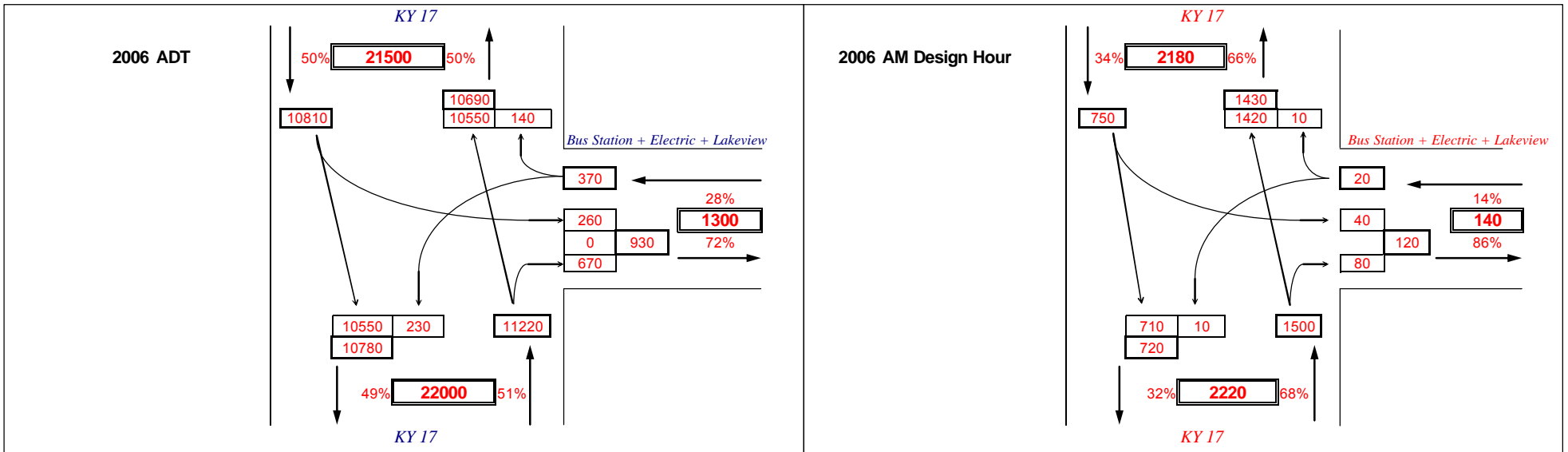

PROJECT: Kenton Co, KY 17 Roundabout Study
 ITEM NUMBER: 0
 MARS NUMBER: 7793519P
 REQUEST DATE 1/10/2006
 ANALYST: D. Hamilton
 SCENARIO: **2030 ADT and Design Hour Volumes**
 INTERSECTION: KY 17 & Bus Station + Electric Dr + Lakeview Dr

NOTE: K-Factors and Directional Distributions were determined from 2006 traffic counts

Assumes proposed planned developments on Lakeview Dr and Electric Dr are built

Assumes proposed planned developments across from Lakeview Dr and Electric Dr are built

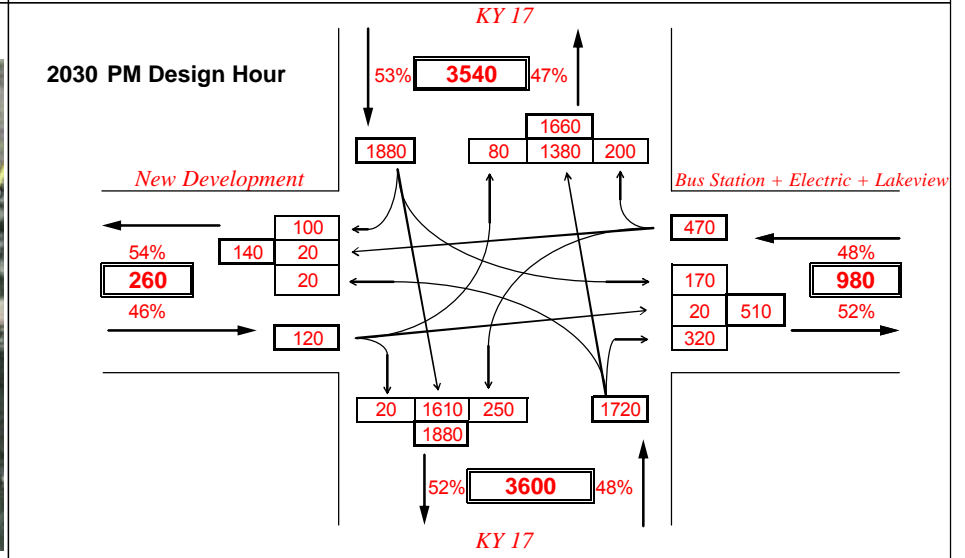
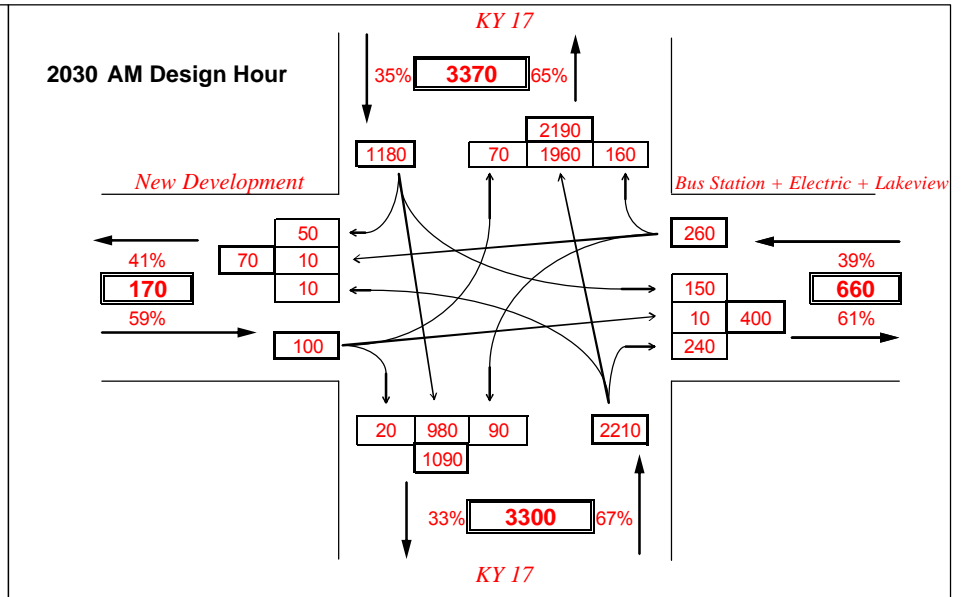
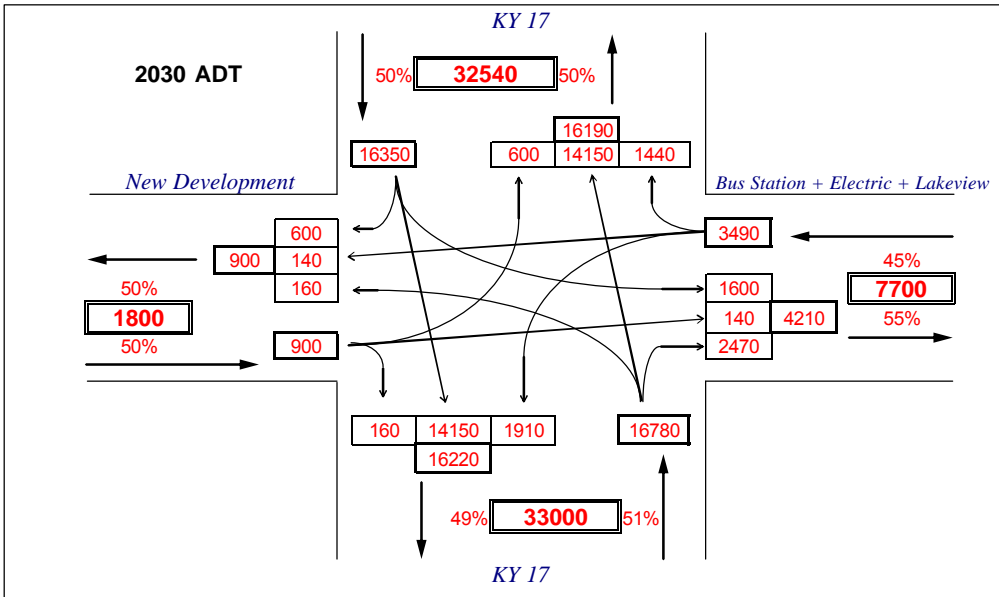

**PLANNED FUTURE
DEVELOPMENTS AND ITS TRIP
RATES IN THE PROJECT AREA**

Northern Kentucky Area Planning Commission

Roundabout Feasibility Study

DLZ Kentucky, Inc., & CDS Associates, Inc.

April 3, 2006

Round-About Study Land Use & Trip Generation Matrix (Net ITE Trips Adjusted for Pass By Traffic)

TAZ #	Owner	Acreage	Proposed	Projected	ITE Land Use	Unit	Density	Total Trips per day	New Total Trips per Day	Passby (Hide Column)	AM Peak Hour Trips	PM Peak Hour Trips	Comments	
1603	1	YK Properties LLC	1.76		Funeral Home	566	per acre	1.76 Ac	9					
1603	2	Butcher, McKinley & Myrtle Brown, William & Jibby Lee	20		Office	710	per 1000 sq ft	15000 SF	310		42	96		
1603					Condos	230	per unit	120 Units	750		60	70		
1603	3	Black, Paul & Irma	8		Office	710	per 1000 sq ft	5000 SF	133		17	85		
1603		Ratermann Bob INC			Office	710	per 1000 sq ft	30000 SF	528		72	112		
1603	4	United Dairy Farmers FW	31.8		Retail	814	per 1000 sq ft	50000 SF	1524		71	99	Adjust for Pass By (30%)	
1603		Shoppes LLC Foreign			Restaurant	932	per 1000 sq ft	8000 SF	580		52	50	Adjust for Pass By (43%)	
1398	5	RT Kentucky Restaurant	1.7	High Turnover Restaurant		932	per 1000 sq ft	8000 SF	580		52	50	Adjust for Pass By (43%)	
1398	6	White Castle KY LLC	1.6	Fast Food with Drive Through		934	per 1000 sq ft	7500 SF	1861		199	130	Adjust for Pass By (50%)	
1398	7	B & Z Development Inc	22		Hotel	310	per room	100 Rooms	892		48	53		
1398	8	BFW Group LTD	1.8		Office	710	per 1000 sq ft	18,000 SF	356		48	99		
1398	22	Rizzo			Fast food with Drive-Through	934	per 1000 sq ft	4,500	1117		120	78	Adjust for Pass By (50%)	
1398	23	B & Z Development Inc	2		Office	710	per 1000 sq ft	5000 SF	133		17	85		
1398		B & Z Development Inc	4		Retail	814	per 1000 sq ft	25000 SF	776		48	57	Adjust for Pass By (30%)	
1420	9	Shoppes of Edgewood	2.4		Service Station with Convenience Market	945	per 1000 sq ft	6000 SF			133	165	Adjust for Pass By (62%)	
1420					Bank	912	per 1000 sq ft	4500 SF	571		30	109	Adjust for Pass By (47%)	
1420	10	Hillside Development Corp	27.8		Home Improvement Super Store	862	per 1000 sq ft	118,000 SF	1874		74	150	Adjust for Pass By (48%)	
1420	11	Taylor, Martin & Helen	3.2		Office	710	per 1000 sq ft	5000 SF	133		17	85		
1420	12		24		Condos	230	per unit	100 Units	642		52	60		
1420	13	Kunkle, Ed Eubank, William & Mary	40	Condos		230	per unit	170 Units	1008		79	93		
1420	14	Roberts, Hannelore & Willard Williams, Glen & Audrey	4.3		Condos	230	per unit	20 Units	164		14	16		
1411		Highland LLC,			Apartments	220	per unit	100 Units	751		53	73		
1411	15	Lies, John & Patricia Hamilton, William & Pamela Younts, Ann Mae Z Square 13 LTD Lee, Marian	30		Shopping center	820	per 1000 sq ft	95000 SF	4335		100	399	Adjust for Pass By (34%)	
1411					Office	710	per 1000 sq ft	80000 SF	1123		157	168		
1411	16	Ratermann, Walter & Nancy	15.9		Park & Ride	90	per parking space	200 Spaces	925		133	121		
1411	17	Morrow Gravel Co Dudley Inc	35		Shopping Center	820	per 1000 sq ft	171,000 SF	6352	2160	34%	143	589	Adjust for Pass By (34%)
1411					Office	710	per 1000 sq ft	120,000 SF	1535		217	213		
1411	18	Taylor, Martin & Helen	4.7		New car sales	841	per 1000 sq ft	25000 SF	833		51	66		
1420	19	Taylor, Martin & Helen	8.7		Service Station with Convenience Market	945	per 1000 sq ft	4500 SF	1953		133	165	Adjust for Pass By (62%)	
1420					Fast food with Drive-Through	934	per 1000 sq ft	4500 SF	1117	559	50%	120	78	Adjust for Pass By (50%)
1412	20	Lakeview Business	5											

1412		Holds Branch Dev. Co. LLC	5.9	Shopping Center		820	per 1000 sq ft	49900 SF	2853	2853		67	261	Adjust for Pass By
1412		Holds Branch Dev. Co. LLC		Condos		230	per unit	258 Units	1437	1437		110	130	
1412		Holds Branch Dev. Co. LLC	44	Single Family Homes		210	per unit	8 Units	101	101		15	11	
1413		Holds Branch Dev. Co. LLC		Condos		230	per unit	2 Units	23	23		3	3	
1413	21	Holds Branch Dev. Co. LLC	13	Single Family Homes		210	per unit	19 units	225	225		23	24	
1417		Holds Branch Dev. Co. LLC	54.9	Apartments		220	per unit	168	1160	1160		86	110	

Round-About Study Land Use & Trip Generation Matrix (Net ITE Trips Adjusted for Pass By Traffic)

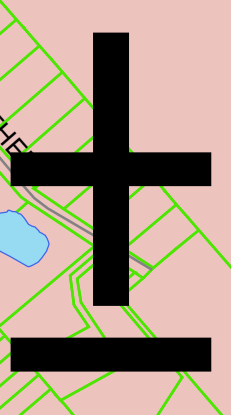
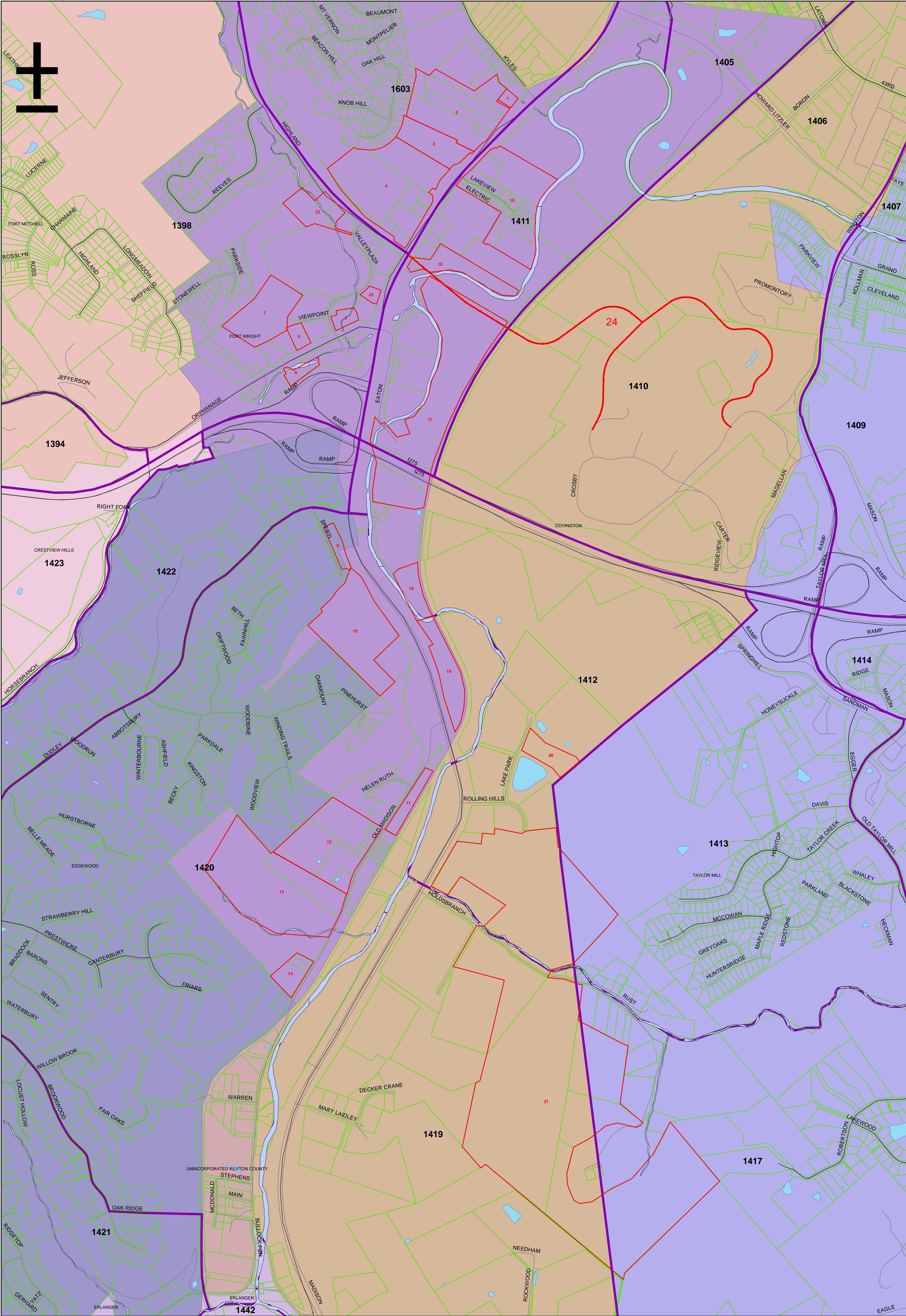

TAZ #	Owner	Acreage	Proposed	Projected	ITE Land Use	Unit	Density	Total Trips per day	New Total Trips per Day	Passby (Hide Column)	AM Peak Hour Trips	PM Peak Hour Trips	Comments
1417	Holds Branch Dev. Co. LLC	54.3	Single Family Homes		210	per unit	82 Units	866	866		67	75	
1419	Holds Branch Dev. Co. LLC	120	Single Family Homes		210	per unit	38 Homes	427	427		36	45	
1419	Holds Branch Dev. Co. LLC		Condos		230	per unit	446 Units	2288	2288		170	205	
1419	Holds Branch Dev. Co. LLC		Apartments		220	per unit	60 Units	510	510		33	51	
1411	24 Fidelity Campus Expansion		Office		*	Per Employee	4700 Employee	11,275	11275		2525	2356	

* Traffic projections for Fidelity Campus Expansion based on February 21 2001 Traffic Impact study prepared by KZF Design Inc.. The study was based on Highland Ave being extended east to the Fidelity Campus. A copy of the Trip Generation Table and exhibit are attached

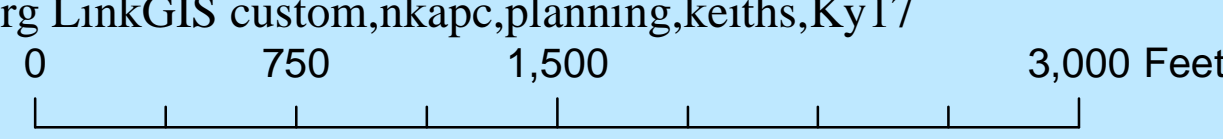

KY17 Kenton County, KY 3/15/06
 NKAPC.org LinkGIS custom,nkpc,planning,keiths,Ky17
 1:6,622

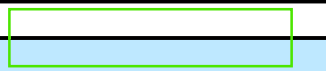
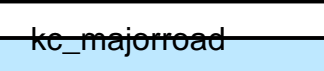

	KC_TAZ_2000		parcel		kc_majorroad
	Future landuse		Fidelity		

TANK Facility Driveway Movements

Typical Weekday

	2006 Traffic			2030 Traffic+	
	South Drive Out Only	North Drive In Out		North Drive In Out	
Fixed Route Buses					
	<u>Time Range</u>				
Early Morning	4a.m. - 6a.m.	41	0	0	
Morning Peak	6a.m. - 9a.m.	38	42	53	
Midday	9a.m. - 3p.m.	48	36	46	
Evening Peak	3p.m. - 6p.m.	32	24	30	
Late Evening	6p.m. - 2a.m.	1	58	74	
School, Training, etc.		15	15	19	
Demand Response Buses					
		90	90	114	
Park & Ride Patrons					
	<u>Time Range</u>				
Morning Peak	6a.m. - 9a.m.		45	57	
Evening Peak	3p.m. - 6p.m.		45		57
TANK Employees / Visitors					
Administration / Visitors *			70	89	89
operators / Maintenance **		300	300	381	
TOTAL MOVEMENTS					
		565	680	115	863
					146

*estimate based on 40 administrative employees making an average of 1.5 trips in/out per day plus 15 visitors.

**estimate based on 200 drivers/mechanics making an average of 1.5 trips in/out per day.



















+ 2030 Traffic based on 1% growth per year as indicated by TANK

MADISON PIKE (KY 17) ROUNDABOUT FEASIBILITY STUDY
NKAPC
Fort Wright / Covington, Kentucky

APPENDIX B

HCM Signalized Intersection Capacity Analysis
 7: Pioneer Park & KY 17 Madison Pike

8/31/2006

												
Movement	EBL	EBT	EBR	WBL	WBT	WBR	NBL	NBT	NBR	SBL	SBT	SBR
Lane Configurations												
Ideal Flow (vphpl)	1900	1900	1900	1900	1900	1900	1900	1900	1900	1900	1900	1900
Total Lost time (s)					4.0			4.0		4.0	4.0	
Lane Util. Factor					1.00			0.95		1.00	0.95	
Frt					0.90			1.00		1.00	1.00	
Flt Protected					0.99			1.00		0.95	1.00	
Satd. Flow (prot)					1596			3402		1703	3406	
Flt Permitted					0.91			1.00		0.04	1.00	
Satd. Flow (perm)					1474			3402		72	3406	
Volume (vph)	0	0	0	20	0	50	0	2880	20	30	690	0
Peak-hour factor, PHF	0.95	0.95	0.95	0.95	0.95	0.95	0.95	0.95	0.95	0.95	0.95	0.95
Adj. Flow (vph)	0	0	0	21	0	53	0	3032	21	32	726	0
RTOR Reduction (vph)	0	0	0	0	5	0	0	0	0	0	0	0
Lane Group Flow (vph)	0	0	0	0	69	0	0	3053	0	32	726	0
Turn Type	Perm		Perm	Perm						Perm		
Protected Phases		4			8			2			6	
Permitted Phases	4		4	8						6		
Actuated Green, G (s)					9.3			97.1		97.1	97.1	
Effective Green, g (s)					10.5			99.1		99.1	99.1	
Actuated g/C Ratio					0.09			0.84		0.84	0.84	
Clearance Time (s)					5.2			6.0		6.0	6.0	
Vehicle Extension (s)					3.0			3.0		3.0	3.0	
Lane Grp Cap (vph)					132			2867		61	2870	
v/s Ratio Prot								c0.90			0.21	
v/s Ratio Perm					c0.05					0.44		
v/c Ratio					0.52			1.06		0.52	0.25	
Uniform Delay, d1					51.1			9.2		2.6	1.8	
Progression Factor					1.00			1.00		1.00	1.00	
Incremental Delay, d2					3.4			37.2		28.7	0.2	
Delay (s)					54.6			46.5		31.3	2.1	
Level of Service					D			D		C	A	
Approach Delay (s)		0.0			54.6			46.5			3.3	
Approach LOS		A			D			D			A	
Intersection Summary												
HCM Average Control Delay			38.2					HCM Level of Service		D		
HCM Volume to Capacity ratio			1.01									
Actuated Cycle Length (s)			117.6					Sum of lost time (s)		8.0		
Intersection Capacity Utilization			91.1%					ICU Level of Service		F		
Analysis Period (min)			15									
c Critical Lane Group												

Lanes, Volumes, Timings
7: Pioneer Park & KY 17 Madison Pike

8/31/2006



Lane Group	EBL	EBT	EBR	WBL	WBT	WBR	NBL	NBT	NBR	SBL	SBT	SBR
Lane Configurations		↕	↗		↕			↕↗		↗	↕↕	
Ideal Flow (vphpl)	1900	1900	1900	1900	1900	1900	1900	1900	1900	1900	1900	1900
Total Lost Time (s)	4.0	4.0	4.0	4.0	4.0	4.0	4.0	4.0	4.0	4.0	4.0	4.0
Leading Detector (ft)	50	50	50	50	50			50		50	50	
Trailing Detector (ft)	0	0	0	0	0			0		0	0	
Turning Speed (mph)	15		9	15		9	15		9	15		9
Lane Util. Factor	1.00	1.00	1.00	1.00	1.00	1.00	1.00	0.95	0.95	1.00	0.95	1.00
Frt					0.903			0.999				
Flt Protected					0.986					0.950		
Satd. Flow (prot)	0	1792	1792	0	1596	0	0	3402	0	1703	3406	0
Flt Permitted					0.924					0.042		
Satd. Flow (perm)	0	1792	1792	0	1496	0	0	3402	0	75	3406	0
Right Turn on Red			Yes			Yes			Yes			Yes
Satd. Flow (RTOR)					6			2				
Headway Factor	1.00	1.00	1.00	1.00	1.00	1.00	1.00	1.00	1.00	1.00	1.00	1.00
Link Speed (mph)		25			35			55			55	
Link Distance (ft)		280			543			1720			1351	
Travel Time (s)		7.6			10.6			21.3			16.7	
Volume (vph)	0	0	0	20	0	50	0	2880	20	30	690	0
Peak Hour Factor	0.95	0.95	0.95	0.95	0.95	0.95	0.95	0.95	0.95	0.95	0.95	0.95
Adj. Flow (vph)	0	0	0	21	0	53	0	3032	21	32	726	0
Lane Group Flow (vph)	0	0	0	0	74	0	0	3053	0	32	726	0
Turn Type	Perm		Perm	Perm						Perm		
Protected Phases		4			8			2			6	
Permitted Phases	4		4	8						6		
Detector Phases	4	4	4	8	8			2		6	6	
Minimum Initial (s)	1.0	1.0	1.0	1.0	1.0			4.0		4.0	4.0	
Minimum Split (s)	6.2	6.2	6.2	6.2	6.2			30.0		30.0	30.0	
Total Split (s)	20.0	20.0	20.0	20.0	20.0	0.0	0.0	99.0	0.0	99.0	99.0	0.0
Total Split (%)	16.8%	16.8%	16.8%	16.8%	16.8%	0.0%	0.0%	83.2%	0.0%	83.2%	83.2%	0.0%
Maximum Green (s)	14.8	14.8	14.8	14.8	14.8			93.0		93.0	93.0	
Yellow Time (s)	3.6	3.6	3.6	3.6	3.6			5.0		5.0	5.0	
All-Red Time (s)	1.6	1.6	1.6	1.6	1.6			1.0		1.0	1.0	
Lead/Lag												
Lead-Lag Optimize?												
Vehicle Extension (s)	3.0	3.0	3.0	3.0	3.0			3.0		3.0	3.0	
Recall Mode	None	None	None	None	None			Max		Max	Max	
Act Effct Green (s)					11.8			99.9		99.9	99.9	
Actuated g/C Ratio					0.10			0.86		0.86	0.86	
v/c Ratio					0.48			1.05		0.50	0.25	
Control Delay					49.8			43.5		36.1	2.4	
Queue Delay					0.0			0.0		0.0	0.0	
Total Delay					49.8			43.5		36.1	2.4	
LOS					D			D		D	A	
Approach Delay					49.8			43.5			3.8	
Approach LOS					D			D			A	
Queue Length 50th (ft)					48			~1336		5	46	
Queue Length 95th (ft)					97			#1554		#25	77	
Internal Link Dist (ft)		200			463			1640			1271	

Lanes, Volumes, Timings
 7: Pioneer Park & KY 17 Madison Pike

8/31/2006



Lane Group	EBL	EBT	EBR	WBL	WBT	WBR	NBL	NBT	NBR	SBL	SBT	SBR
Turn Bay Length (ft)												
Base Capacity (vph)					200			2914		64	2917	
Starvation Cap Reductn					0			0		0	0	
Spillback Cap Reductn					0			0		0	0	
Storage Cap Reductn					0			0		0	0	
Reduced v/c Ratio					0.37			1.05		0.50	0.25	

Intersection Summary





















Area Type: Other
 Cycle Length: 119
 Actuated Cycle Length: 116.7
 Natural Cycle: 150
 Control Type: Actuated-Uncoordinated
 Maximum v/c Ratio: 1.05
 Intersection Signal Delay: 35.9 Intersection LOS: D
 Intersection Capacity Utilization 91.1% ICU Level of Service F
 Analysis Period (min) 15
 ~ Volume exceeds capacity, queue is theoretically infinite.
 Queue shown is maximum after two cycles.
 # 95th percentile volume exceeds capacity, queue may be longer.
 Queue shown is maximum after two cycles.

Splits and Phases: 7: Pioneer Park & KY 17 Madison Pike

↑ ø2	→ ø4
99 s	20 s
↓ ø6	← ø8
99 s	20 s

HCM Signalized Intersection Capacity Analysis
 7: Pioneer Park & KY 17 Madison Pike

8/31/2006

													
Movement	EBL	EBT	EBR	WBL	WBT	WBR	NBL	NBT	NBR	SBL	SBT	SBR	
Lane Configurations													
Ideal Flow (vphpl)	1900	1900	1900	1900	1900	1900	1900	1900	1900	1900	1900	1900	
Total Lost time (s)					4.0			4.0		4.0	4.0		
Lane Util. Factor					1.00			0.95		1.00	0.95		
Frt					0.90			0.99		1.00	1.00		
Flt Protected					0.99			1.00		0.95	1.00		
Satd. Flow (prot)					1596			3380		1703	3406		
Flt Permitted					0.91			1.00		0.05	1.00		
Satd. Flow (perm)					1464			3380		89	3406		
Volume (vph)	0	0	0	150	0	410	0	2990	150	250	1160	0	
Peak-hour factor, PHF	0.95	0.95	0.95	0.95	0.95	1.00	0.95	1.00	0.95	0.95	0.95	0.95	
Adj. Flow (vph)	0	0	0	158	0	410	0	2990	158	263	1221	0	
RTOR Reduction (vph)	0	0	0	0	74	0	0	3	0	0	0	0	
Lane Group Flow (vph)	0	0	0	0	494	0	0	3145	0	263	1221	0	
Turn Type	Perm		Perm	Perm						pm+pt			
Protected Phases		4			8			2		1	6		
Permitted Phases	4		4	8						6			
Actuated Green, G (s)					26.8			75.0		87.0	87.0		
Effective Green, g (s)					28.0			77.0		89.0	89.0		
Actuated g/C Ratio					0.22			0.62		0.71	0.71		
Clearance Time (s)					5.2			6.0		4.0	6.0		
Lane Grp Cap (vph)					328			2082		167	2425		
v/s Ratio Prot								0.93		c0.10	0.36		
v/s Ratio Perm					c0.34					c1.03			
v/c Ratio					1.50			1.51		1.57	0.50		
Uniform Delay, d1					48.5			24.0		60.7	8.1		
Progression Factor					1.00			1.00		1.00	1.00		
Incremental Delay, d2					242.4			232.3		285.4	0.8		
Delay (s)					290.9			256.3		346.2	8.8		
Level of Service					F			F		F	A		
Approach Delay (s)		0.0			290.9			256.3			68.6		
Approach LOS		A			F			F			E		
Intersection Summary													
HCM Average Control Delay			206.5									HCM Level of Service	F
HCM Volume to Capacity ratio			1.54										
Actuated Cycle Length (s)			125.0									Sum of lost time (s)	8.0
Intersection Capacity Utilization			144.8%									ICU Level of Service	H
Analysis Period (min)			15										
c Critical Lane Group													

Lanes, Volumes, Timings
 7: Pioneer Park & KY 17 Madison Pike

8/31/2006



Lane Group	EBL	EBT	EBR	WBL	WBT	WBR	NBL	NBT	NBR	SBL	SBT	SBR
Lane Configurations		↕	↗		↕			↕↗		↗	↕↕	
Ideal Flow (vphpl)	1900	1900	1900	1900	1900	1900	1900	1900	1900	1900	1900	1900
Total Lost Time (s)	4.0	4.0	4.0	4.0	4.0	4.0	4.0	4.0	4.0	4.0	4.0	4.0
Turning Speed (mph)	15		9	15		9	15		9	15		9
Lane Util. Factor	1.00	1.00	1.00	1.00	1.00	1.00	1.00	0.95	0.95	1.00	0.95	1.00
Frt					0.903			0.992				
Flt Protected					0.986					0.950		
Satd. Flow (prot)	0	1792	1792	0	1596	0	0	3378	0	1703	3406	0
Flt Permitted					0.905					0.049		
Satd. Flow (perm)	0	1792	1792	0	1465	0	0	3378	0	88	3406	0
Right Turn on Red			Yes			Yes			Yes			Yes
Satd. Flow (RTOR)					96			8				
Headway Factor	1.00	1.00	1.00	1.00	1.00	1.00	1.00	1.00	1.00	1.00	1.00	1.00
Link Speed (mph)		25			35			55			55	
Link Distance (ft)		280			543			1720			1351	
Travel Time (s)		7.6			10.6			21.3			16.7	
Volume (vph)	0	0	0	150	0	410	0	2990	150	250	1160	0
Peak Hour Factor	0.95	0.95	0.95	0.95	0.95	1.00	0.95	1.00	0.95	0.95	0.95	0.95
Adj. Flow (vph)	0	0	0	158	0	410	0	2990	158	263	1221	0
Lane Group Flow (vph)	0	0	0	0	568	0	0	3148	0	263	1221	0
Turn Type	Perm		Perm	Perm						pm+pt		
Protected Phases		4			8			2		1	6	
Permitted Phases	4		4	8						6		
Minimum Split (s)	20.0	20.0	20.0	20.0	20.0			30.0		8.0	30.0	
Total Split (s)	32.0	32.0	32.0	32.0	32.0	0.0	0.0	81.0	0.0	12.0	93.0	0.0
Total Split (%)	25.6%	25.6%	25.6%	25.6%	25.6%	0.0%	0.0%	64.8%	0.0%	9.6%	74.4%	0.0%
Maximum Green (s)	26.8	26.8	26.8	26.8	26.8			75.0		8.0	87.0	
Yellow Time (s)	3.6	3.6	3.6	3.6	3.6			5.0		3.5	5.0	
All-Red Time (s)	1.6	1.6	1.6	1.6	1.6			1.0		0.5	1.0	
Lead/Lag								Lag		Lead		
Lead-Lag Optimize?								Yes		Yes		
Walk Time (s)	5.0	5.0	5.0	5.0	5.0			5.0			5.0	
Flash Dont Walk (s)	11.0	11.0	11.0	11.0	11.0			11.0			11.0	
Pedestrian Calls (#/hr)	0	0	0	0	0			0			0	
Act Effct Green (s)					28.0			77.0		89.0	89.0	
Actuated g/C Ratio					0.22			0.62		0.71	0.71	
v/c Ratio					1.41			1.51		1.58	0.50	
Control Delay					229.5			256.2		315.9	9.0	
Queue Delay					0.0			0.0		0.0	0.0	
Total Delay					229.5			256.2		315.9	9.0	
LOS					F			F		F	A	
Approach Delay					229.5			256.2			63.3	
Approach LOS					F			F			E	
Queue Length 50th (ft)					~556			~1877		~256	208	
Queue Length 95th (ft)					#782			#1995		#430	253	
Internal Link Dist (ft)		200			463			1640			1271	
Turn Bay Length (ft)												
Base Capacity (vph)					403			2084		166	2425	
Starvation Cap Reductn					0			0		0	0	

KY 17 @ Holds Branch am No Build
 DLZ, LLC

Synchro 6 Report

Lanes, Volumes, Timings
 7: Pioneer Park & KY 17 Madison Pike

8/31/2006



Lane Group	EBL	EBT	EBR	WBL	WBT	WBR	NBL	NBT	NBR	SBL	SBT	SBR
Spillback Cap Reductn					0			0		0	0	
Storage Cap Reductn					0			0		0	0	
Reduced v/c Ratio					1.41			1.51		1.58	0.50	

Intersection Summary





















Area Type:	Other
Cycle Length:	125
Actuated Cycle Length:	125
Offset:	0 (0%), Referenced to phase 2:NBT and 6:SBTL, Start of Green
Natural Cycle:	150
Control Type:	Pretimed
Maximum v/c Ratio:	1.58
Intersection Signal Delay:	198.2
Intersection LOS:	F
Intersection Capacity Utilization	144.8%
ICU Level of Service	H
Analysis Period (min)	15
~	Volume exceeds capacity, queue is theoretically infinite. Queue shown is maximum after two cycles.
#	95th percentile volume exceeds capacity, queue may be longer. Queue shown is maximum after two cycles.

Splits and Phases: 7: Pioneer Park & KY 17 Madison Pike



HCM Signalized Intersection Capacity Analysis
 7: Pioneer Park & KY 17 Madison Pike

8/31/2006

												
Movement	EBL	EBT	EBR	WBL	WBT	WBR	NBL	NBT	NBR	SBL	SBT	SBR
Lane Configurations												
Ideal Flow (vphpl)	1900	1900	1900	1900	1900	1900	1900	1900	1900	1900	1900	1900
Total Lost time (s)				4.0		4.0		4.0	4.0	4.0	4.0	
Lane Util. Factor				1.00		0.88		0.91	1.00	0.97	0.91	
Frt				1.00		0.85		1.00	0.85	1.00	1.00	
Flt Protected				0.95		1.00		1.00	1.00	0.95	1.00	
Satd. Flow (prot)				1703		2682		4893	1524	3303	4893	
Flt Permitted				0.95		1.00		1.00	1.00	0.95	1.00	
Satd. Flow (perm)				1703		2682		4893	1524	3303	4893	
Volume (vph)	0	0	0	150	0	410	0	2990	150	250	1160	0
Peak-hour factor, PHF	0.95	0.95	0.95	0.95	0.95	1.00	0.95	1.00	0.95	0.95	0.95	0.95
Adj. Flow (vph)	0	0	0	158	0	410	0	2990	158	263	1221	0
RTOR Reduction (vph)	0	0	0	0	0	186	0	0	12	0	0	0
Lane Group Flow (vph)	0	0	0	158	0	224	0	2990	146	263	1221	0
Turn Type	Perm			Prot		custom			Perm		Prot	
Protected Phases		4		3				2		1	6	
Permitted Phases	4					8			2			
Actuated Green, G (s)				13.0		20.5		80.5	80.5	10.5	95.5	
Effective Green, g (s)				13.0		21.0		81.0	81.0	11.0	96.0	
Actuated g/C Ratio				0.10		0.17		0.65	0.65	0.09	0.77	
Clearance Time (s)				4.0		4.5		4.5	4.5	4.5	4.5	
Lane Grp Cap (vph)				177		451		3171	988	291	3758	
v/s Ratio Prot				c0.09				c0.61		c0.08	0.25	
v/s Ratio Perm						c0.08			0.10			
v/c Ratio				0.89		0.50		0.94	0.15	0.90	0.32	
Uniform Delay, d1				55.3		47.2		19.9	8.6	56.5	4.5	
Progression Factor				1.00		1.00		1.00	1.00	1.00	1.00	
Incremental Delay, d2				44.2		3.9		7.3	0.3	33.0	0.2	
Delay (s)				99.5		51.1		27.2	8.9	89.5	4.7	
Level of Service				F		D		C	A	F	A	
Approach Delay (s)		0.0			64.5			26.3			19.7	
Approach LOS		A			E			C			B	
Intersection Summary												
HCM Average Control Delay			28.6				HCM Level of Service			C		
HCM Volume to Capacity ratio			0.90									
Actuated Cycle Length (s)			125.0				Sum of lost time (s)		12.0			
Intersection Capacity Utilization			83.2%				ICU Level of Service		E			
Analysis Period (min)			15									
c	Critical Lane Group											

Lanes, Volumes, Timings
 7: Pioneer Park & KY 17 Madison Pike





















8/31/2006



Lane Group	EBL	EBT	EBR	WBL	WBT	WBR	NBL	NBT	NBR	SBL	SBT	SBR
Lane Configurations	↖	↗		↖		↖↗		↑↑↑	↖	↖↗	↑↑↑	
Ideal Flow (vphpl)	1900	1900	1900	1900	1900	1900	1900	1900	1900	1900	1900	1900
Storage Length (ft)	50		50	400		150	550		50	300		0
Storage Lanes	1		0	1		1	0		1	2		0
Total Lost Time (s)	4.0	4.0	4.0	4.0	4.0	4.0	4.0	4.0	4.0	4.0	4.0	4.0
Turning Speed (mph)	15		9	15		9	15		9	15		9
Lane Util. Factor	1.00	1.00	1.00	1.00	1.00	0.88	1.00	0.91	1.00	0.97	0.91	1.00
Fr _t						0.850			0.850			
Fl _t Protected				0.950						0.950		
Satd. Flow (prot)	1792	1792	0	1703	0	2682	0	4893	1524	3303	4893	0
Fl _t Permitted				0.950						0.950		
Satd. Flow (perm)	1792	1792	0	1703	0	2682	0	4893	1524	3303	4893	0
Right Turn on Red			Yes			Yes			Yes			Yes
Satd. Flow (RTOR)						224			35			
Headway Factor	1.00	1.00	1.00	1.00	1.00	1.00	1.00	1.00	1.00	1.00	1.00	1.00
Link Speed (mph)		25			35			55			55	
Link Distance (ft)		280			543			1720			1351	
Travel Time (s)		7.6			10.6			21.3			16.7	
Volume (vph)	0	0	0	150	0	410	0	2990	150	250	1160	0
Peak Hour Factor	0.95	0.95	0.95	0.95	0.95	1.00	0.95	1.00	0.95	0.95	0.95	0.95
Adj. Flow (vph)	0	0	0	158	0	410	0	2990	158	263	1221	0
Lane Group Flow (vph)	0	0	0	158	0	410	0	2990	158	263	1221	0
Turn Type	Perm			Prot		custom			Perm	Prot		
Protected Phases		4		3				2		1		6
Permitted Phases	4					8			2			
Minimum Split (s)	8.0	8.0		8.0		24.0		30.0	30.0	8.5	30.0	
Total Split (s)	8.0	8.0	0.0	17.0	0.0	25.0	0.0	85.0	85.0	15.0	100.0	0.0
Total Split (%)	6.4%	6.4%	0.0%	13.6%	0.0%	20.0%	0.0%	68.0%	68.0%	12.0%	80.0%	0.0%
Maximum Green (s)	3.5	3.5		13.0		20.5		80.5	80.5	10.5	95.5	
Yellow Time (s)	3.5	3.5		3.5		3.5		3.5	3.5	3.5	3.5	
All-Red Time (s)	1.0	1.0		0.5		1.0		1.0	1.0	1.0	1.0	
Lead/Lag	Lag	Lag		Lead				Lag	Lag	Lead		
Lead-Lag Optimize?	Yes	Yes		Yes				Yes	Yes	Yes		
Walk Time (s)	5.0	5.0				5.0		5.0	5.0		5.0	
Flash Dont Walk (s)	11.0	11.0				11.0		11.0	11.0		11.0	
Pedestrian Calls (#/hr)	0	0				0		0	0		0	
Act Effct Green (s)				13.0		21.0		81.0	81.0	11.0	96.0	
Actuated g/C Ratio				0.10		0.17		0.65	0.65	0.09	0.77	
v/c Ratio				0.89		0.64		0.94	0.16	0.90	0.32	
Control Delay				99.8		26.7		27.7	7.0	89.6	4.7	
Queue Delay				0.0		0.0		0.0	0.0	0.0	0.0	
Total Delay				99.8		26.7		27.7	7.0	89.6	4.7	
LOS				F		C		C	A	F	A	
Approach Delay								26.6			19.8	
Approach LOS								C			B	
Queue Length 50th (ft)				128		78		744	35	110	95	
Queue Length 95th (ft)				#258		140		837	63	#190	112	
Internal Link Dist (ft)		200			463			1640			1271	
Turn Bay Length (ft)				400		150			50	300		

HCM Signalized Intersection Capacity Analysis
 7: Pioneer Park & KY 17 Madison Pike

8/31/2006

												
Movement	EBL	EBT	EBR	WBL	WBT	WBR	NBL	NBT	NBR	SBL	SBT	SBR
Lane Configurations												
Ideal Flow (vphpl)	1900	1900	1900	1900	1900	1900	1900	1900	1900	1900	1900	1900
Total Lost time (s)		4.0	4.0		4.0			4.0		4.0	4.0	
Lane Util. Factor		1.00	1.00		1.00			0.95		1.00	0.95	
Frt		1.00	0.85		0.91			1.00		1.00	1.00	
Flt Protected		0.97	1.00		0.98			1.00		0.95	1.00	
Satd. Flow (prot)		1733	1524		1605			3401		1703	3406	
Flt Permitted		0.66	1.00		0.88			1.00		0.24	1.00	
Satd. Flow (perm)		1177	1524		1439			3401		439	3406	
Volume (vph)	10	5	10	30	0	60	0	1050	10	40	2280	0
Peak-hour factor, PHF	0.95	0.95	0.95	0.95	0.95	0.95	0.95	0.95	0.95	0.95	0.95	0.95
Adj. Flow (vph)	11	5	11	32	0	63	0	1105	11	42	2400	0
RTOR Reduction (vph)	0	0	10	0	58	0	0	0	0	0	0	0
Lane Group Flow (vph)	0	16	1	0	37	0	0	1116	0	42	2400	0
Turn Type	Perm		Perm	Perm						Perm		
Protected Phases		4			8			2			6	
Permitted Phases	4		4	8						6		
Actuated Green, G (s)		7.5	7.5		7.5			95.9		95.9	95.9	
Effective Green, g (s)		8.7	8.7		8.7			97.9		97.9	97.9	
Actuated g/C Ratio		0.08	0.08		0.08			0.85		0.85	0.85	
Clearance Time (s)		5.2	5.2		5.2			6.0		6.0	6.0	
Vehicle Extension (s)		3.0	3.0		3.0			3.0		3.0	3.0	
Lane Grp Cap (vph)		89	116		109			2905		375	2910	
v/s Ratio Prot								0.33			c0.70	
v/s Ratio Perm		0.01	0.00		c0.03					0.10		
v/c Ratio		0.18	0.01		0.34			0.38		0.11	0.82	
Uniform Delay, d1		49.6	49.0		50.2			1.8		1.3	4.1	
Progression Factor		1.00	1.00		1.00			1.00		1.00	1.00	
Incremental Delay, d2		1.0	0.0		1.8			0.4		0.6	2.8	
Delay (s)		50.6	49.0		52.1			2.2		2.0	6.9	
Level of Service		D	D		D			A		A	A	
Approach Delay (s)		49.9			52.1			2.2			6.8	
Approach LOS		D			D			A			A	
Intersection Summary												
HCM Average Control Delay			6.9					HCM Level of Service			A	
HCM Volume to Capacity ratio			0.78									
Actuated Cycle Length (s)			114.6					Sum of lost time (s)		8.0		
Intersection Capacity Utilization			81.7%					ICU Level of Service		D		
Analysis Period (min)			15									
c Critical Lane Group												

Lanes, Volumes, Timings
7: Pioneer Park & KY 17 Madison Pike

8/31/2006



Lane Group	EBL	EBT	EBR	WBL	WBT	WBR	NBL	NBT	NBR	SBL	SBT	SBR
Lane Configurations		↕	↗		↕			↕↗		↗	↕↕	
Ideal Flow (vphpl)	1900	1900	1900	1900	1900	1900	1900	1900	1900	1900	1900	1900
Total Lost Time (s)	4.0	4.0	4.0	4.0	4.0	4.0	4.0	4.0	4.0	4.0	4.0	4.0
Leading Detector (ft)	50	50	50	50	50			50		50	50	
Trailing Detector (ft)	0	0	0	0	0			0		0	0	
Turning Speed (mph)	15		9	15		9	15		9	15		9
Lane Util. Factor	1.00	1.00	1.00	1.00	1.00	1.00	1.00	0.95	0.95	1.00	0.95	1.00
Fr _t			0.850		0.910			0.999				
Fl _t Protected		0.967			0.983					0.950		
Satd. Flow (prot)	0	1733	1524	0	1603	0	0	3402	0	1703	3406	0
Fl _t Permitted		0.868			0.897					0.235		
Satd. Flow (perm)	0	1556	1524	0	1463	0	0	3402	0	421	3406	0
Right Turn on Red			Yes			Yes			Yes			Yes
Satd. Flow (RTOR)			11		63			3				
Headway Factor	1.00	1.00	1.00	1.00	1.00	1.00	1.00	1.00	1.00	1.00	1.00	1.00
Link Speed (mph)		25			35			55			55	
Link Distance (ft)		280			543			1720			1351	
Travel Time (s)		7.6			10.6			21.3			16.7	
Volume (vph)	10	5	10	30	0	60	0	1050	10	40	2280	0
Peak Hour Factor	0.95	0.95	0.95	0.95	0.95	0.95	0.95	0.95	0.95	0.95	0.95	0.95
Adj. Flow (vph)	11	5	11	32	0	63	0	1105	11	42	2400	0
Lane Group Flow (vph)	0	16	11	0	95	0	0	1116	0	42	2400	0
Turn Type	Perm		Perm	Perm						Perm		
Protected Phases		4			8			2			6	
Permitted Phases	4		4	8						6		
Detector Phases	4	4	4	8	8			2		6	6	
Minimum Initial (s)	1.0	1.0	1.0	1.0	1.0			4.0		4.0	4.0	
Minimum Split (s)	6.2	6.2	6.2	6.2	6.2			30.0		30.0	30.0	
Total Split (s)	20.0	20.0	20.0	20.0	20.0	0.0	0.0	99.0	0.0	99.0	99.0	0.0
Total Split (%)	16.8%	16.8%	16.8%	16.8%	16.8%	0.0%	0.0%	83.2%	0.0%	83.2%	83.2%	0.0%
Maximum Green (s)	14.8	14.8	14.8	14.8	14.8			93.0		93.0	93.0	
Yellow Time (s)	3.6	3.6	3.6	3.6	3.6			5.0		5.0	5.0	
All-Red Time (s)	1.6	1.6	1.6	1.6	1.6			1.0		1.0	1.0	
Lead/Lag												
Lead-Lag Optimize?												
Vehicle Extension (s)	3.0	3.0	3.0	3.0	3.0			3.0		3.0	3.0	
Recall Mode	None	None	None	None	None			Max		Max	Max	
Act Effct Green (s)		9.8	9.8		9.8			98.7		98.7	98.7	
Actuated g/C Ratio		0.08	0.08		0.08			0.87		0.87	0.87	
v/c Ratio		0.12	0.08		0.52			0.38		0.11	0.81	
Control Delay		47.6	23.1		24.5			2.5		2.8	8.0	
Queue Delay		0.0	0.0		0.0			0.0		0.0	0.0	
Total Delay		47.6	23.1		24.5			2.5		2.8	8.0	
LOS		D	C		C			A		A	A	
Approach Delay		37.6			24.5			2.5			7.9	
Approach LOS		D			C			A			A	
Queue Length 50th (ft)		11	0		22			67		4	331	
Queue Length 95th (ft)		33	18		75			126		14	640	
Internal Link Dist (ft)		200			463			1640			1271	

Lanes, Volumes, Timings
 7: Pioneer Park & KY 17 Madison Pike

8/31/2006



Lane Group	EBL	EBT	EBR	WBL	WBT	WBR	NBL	NBT	NBR	SBL	SBT	SBR
Turn Bay Length (ft)												
Base Capacity (vph)		205	210		247			2958		366	2961	
Starvation Cap Reductn		0	0		0			0		0	0	
Spillback Cap Reductn		0	0		0			0		0	0	
Storage Cap Reductn		0	0		0			0		0	0	
Reduced v/c Ratio		0.08	0.05		0.38			0.38		0.11	0.81	

Intersection Summary

Area Type:	Other
Cycle Length:	119
Actuated Cycle Length:	113.5
Natural Cycle:	50
Control Type:	Actuated-Uncoordinated
Maximum v/c Ratio:	0.81
Intersection Signal Delay:	6.9
Intersection LOS:	A
Intersection Capacity Utilization	81.7%
ICU Level of Service	D
Analysis Period (min)	15

Splits and Phases: 7: Pioneer Park & KY 17 Madison Pike



HCM Signalized Intersection Capacity Analysis

7: Pioneer Park & KY 17 Madison Pike

8/31/2006



Movement	EBL	EBT	EBR	WBL	WBT	WBR	NBL	NBT	NBR	SBL	SBT	SBR
Lane Configurations		↕	↗		↔			↕↔		↗	↕↕	
Ideal Flow (vphpl)	1900	1900	1900	1900	1900	1900	1900	1900	1900	1900	1900	1900
Total Lost time (s)		4.0	4.0		4.0			4.0		4.0	4.0	
Lane Util. Factor		1.00	1.00		1.00			0.95		1.00	0.95	
Frt		1.00	0.85		0.91			0.99		1.00	1.00	
Flt Protected		0.97	1.00		0.98			1.00		0.95	1.00	
Satd. Flow (prot)		1733	1524		1601			3384		1703	3406	
Flt Permitted		0.68	1.00		0.89			1.00		0.05	1.00	
Satd. Flow (perm)		1216	1524		1446			3384		94	3406	
Volume (vph)	10	5	10	260	0	560	0	1840	80	380	2520	0
Peak-hour factor, PHF	0.95	0.95	0.97	0.97	0.95	0.95	0.95	0.95	0.95	0.95	0.97	0.95
Adj. Flow (vph)	11	5	10	268	0	589	0	1937	84	400	2598	0
RTOR Reduction (vph)	0	0	6	0	63	0	0	3	0	0	0	0
Lane Group Flow (vph)	0	16	4	0	794	0	0	2018	0	400	2598	0
Turn Type	Perm		Perm	Perm						pm+pt		
Protected Phases		4			8			2		1	6	
Permitted Phases	4		4	8						6		
Actuated Green, G (s)		24.8	24.8		24.8			70.0		89.0	89.0	
Effective Green, g (s)		26.0	26.0		26.0			72.0		91.0	91.0	
Actuated g/C Ratio		0.21	0.21		0.21			0.58		0.73	0.73	
Clearance Time (s)		5.2	5.2		5.2			6.0		4.0	6.0	
Lane Grp Cap (vph)		253	317		301			1949		262	2480	
v/s Ratio Prot								0.60		c0.18	0.76	
v/s Ratio Perm		0.01	0.00		c0.55					c0.93		
v/c Ratio		0.06	0.01		2.64			1.04		1.53	1.05	
Uniform Delay, d1		39.7	39.3		49.5			26.5		57.2	17.0	
Progression Factor		1.00	1.00		1.00			1.00		1.00	1.00	
Incremental Delay, d2		0.5	0.1		746.0			30.3		255.5	32.1	
Delay (s)		40.2	39.4		795.5			56.8		312.7	49.1	
Level of Service		D	D		F			E		F	D	
Approach Delay (s)		39.9			795.5			56.8			84.3	
Approach LOS		D			F			E			F	

Intersection Summary

HCM Average Control Delay	177.9	HCM Level of Service	F
HCM Volume to Capacity ratio	1.76		
Actuated Cycle Length (s)	125.0	Sum of lost time (s)	8.0
Intersection Capacity Utilization	140.0%	ICU Level of Service	H
Analysis Period (min)	15		

c Critical Lane Group

Lanes, Volumes, Timings
 7: Pioneer Park & KY 17 Madison Pike

8/31/2006



Lane Group	EBL	EBT	EBR	WBL	WBT	WBR	NBL	NBT	NBR	SBL	SBT	SBR
Lane Configurations		↕	↗		↕			↕↗		↗	↕↕	
Ideal Flow (vphpl)	1900	1900	1900	1900	1900	1900	1900	1900	1900	1900	1900	1900
Total Lost Time (s)	4.0	4.0	4.0	4.0	4.0	4.0	4.0	4.0	4.0	4.0	4.0	4.0
Turning Speed (mph)	15		9	15		9	15		9	15		9
Lane Util. Factor	1.00	1.00	1.00	1.00	1.00	1.00	1.00	0.95	0.95	1.00	0.95	1.00
Fr _t			0.850		0.907			0.994				
Fl _t Protected		0.967			0.985					0.950		
Satd. Flow (prot)	0	1733	1524	0	1601	0	0	3385	0	1703	3406	0
Fl _t Permitted		0.678			0.889					0.053		
Satd. Flow (perm)	0	1215	1524	0	1445	0	0	3385	0	95	3406	0
Right Turn on Red			Yes			Yes			Yes			Yes
Satd. Flow (RTOR)			8		80			6				
Headway Factor	1.00	1.00	1.00	1.00	1.00	1.00	1.00	1.00	1.00	1.00	1.00	1.00
Link Speed (mph)		25			35			55			55	
Link Distance (ft)		280			543			1720			1351	
Travel Time (s)		7.6			10.6			21.3			16.7	
Volume (vph)	10	5	10	260	0	560	0	1840	80	380	2520	0
Peak Hour Factor	0.95	0.95	0.97	0.97	0.95	0.95	0.95	0.95	0.95	0.95	0.97	0.95
Adj. Flow (vph)	11	5	10	268	0	589	0	1937	84	400	2598	0
Lane Group Flow (vph)	0	16	10	0	857	0	0	2021	0	400	2598	0
Turn Type	Perm		Perm	Perm						pm+pt		
Protected Phases		4			8			2		1	6	
Permitted Phases	4		4	8						6		
Minimum Split (s)	20.0	20.0	20.0	20.0	20.0			30.0		8.0	30.0	
Total Split (s)	30.0	30.0	30.0	30.0	30.0	0.0	0.0	76.0	0.0	19.0	95.0	0.0
Total Split (%)	24.0%	24.0%	24.0%	24.0%	24.0%	0.0%	0.0%	60.8%	0.0%	15.2%	76.0%	0.0%
Maximum Green (s)	24.8	24.8	24.8	24.8	24.8			70.0		15.0	89.0	
Yellow Time (s)	3.6	3.6	3.6	3.6	3.6			5.0		3.5	5.0	
All-Red Time (s)	1.6	1.6	1.6	1.6	1.6			1.0		0.5	1.0	
Lead/Lag								Lag		Lead		
Lead-Lag Optimize?								Yes		Yes		
Walk Time (s)	5.0	5.0	5.0	5.0	5.0			5.0			5.0	
Flash Dont Walk (s)	11.0	11.0	11.0	11.0	11.0			11.0			11.0	
Pedestrian Calls (#/hr)	0	0	0	0	0			0			0	
Act Effct Green (s)		26.0	26.0		26.0			72.0		91.0	91.0	
Actuated g/C Ratio		0.21	0.21		0.21			0.58		0.73	0.73	
v/c Ratio		0.06	0.03		2.35			1.04		1.53	1.05	
Control Delay		40.7	23.8		639.6			56.9		285.1	50.3	
Queue Delay		0.0	0.0		0.0			0.0		0.0	0.0	
Total Delay		40.7	23.8		639.6			56.9		285.1	50.3	
LOS		D	C		F			E		F	D	
Approach Delay		34.2			639.6			56.9			81.7	
Approach LOS		C			F			E			F	
Queue Length 50th (ft)		11	1		~1093			~924		~406	~1202	
Queue Length 95th (ft)		31	17		#1345			#1063		#609	#1330	
Internal Link Dist (ft)		200			463			1640			1271	
Turn Bay Length (ft)												
Base Capacity (vph)		253	323		364			1952		262	2480	
Starvation Cap Reductn		0	0		0			0		0	0	

KY 17 @ Holds Branch pm No Build
 DLZ, LLC

Synchro 6 Report

Lanes, Volumes, Timings
 7: Pioneer Park & KY 17 Madison Pike

8/31/2006



Lane Group	EBL	EBT	EBR	WBL	WBT	WBR	NBL	NBT	NBR	SBL	SBT	SBR
Spillback Cap Reductn		0	0		0			0		0	0	
Storage Cap Reductn		0	0		0			0		0	0	
Reduced v/c Ratio		0.06	0.03		2.35			1.04		1.53	1.05	

Intersection Summary

Area Type:	Other
Cycle Length:	125
Actuated Cycle Length:	125
Offset:	0 (0%), Referenced to phase 2:NBT and 6:SBTL, Start of Green
Natural Cycle:	75
Control Type:	Pretimed
Maximum v/c Ratio:	2.35
Intersection Signal Delay:	154.0
Intersection LOS:	F
Intersection Capacity Utilization	140.0%
ICU Level of Service	H
Analysis Period (min)	15
~	Volume exceeds capacity, queue is theoretically infinite. Queue shown is maximum after two cycles.
#	95th percentile volume exceeds capacity, queue may be longer. Queue shown is maximum after two cycles.

Splits and Phases: 7: Pioneer Park & KY 17 Madison Pike



HCM Signalized Intersection Capacity Analysis

7: Pioneer Park & KY 17 Madison Pike

8/31/2006

Movement	EBL	EBT	EBR	WBL	WBT	WBR	NBL	NBT	NBR	SBL	SBT	SBR
Lane Configurations												
Ideal Flow (vphpl)	1900	1900	1900	1900	1900	1900	1900	1900	1900	1900	1900	1900
Total Lost time (s)	4.0	4.0		4.0		4.0		4.0	4.0	4.0	4.0	
Lane Util. Factor	1.00	1.00		1.00		0.88		0.91	1.00	0.97	0.91	
Frt	1.00	0.90		1.00		0.85		1.00	0.85	1.00	1.00	
Flt Protected	0.95	1.00		0.95		1.00		1.00	1.00	0.95	1.00	
Satd. Flow (prot)	1703	1613		1703		2682		4893	1524	3303	4893	
Flt Permitted	0.95	1.00		0.95		1.00		1.00	1.00	0.95	1.00	
Satd. Flow (perm)	1703	1613		1703		2682		4893	1524	3303	4893	
Volume (vph)	10	5	10	260	0	560	0	1840	80	380	2520	0
Peak-hour factor, PHF	0.95	0.95	0.97	0.97	0.95	0.95	0.95	0.95	0.95	0.95	0.97	0.95
Adj. Flow (vph)	11	5	10	268	0	589	0	1937	84	400	2598	0
RTOR Reduction (vph)	0	10	0	0	0	518	0	0	10	0	0	0
Lane Group Flow (vph)	11	5	0	268	0	71	0	1937	74	400	2598	0
Turn Type	Prot			Prot		custom			Perm		Prot	
Protected Phases	7	4		3				2		1	6	
Permitted Phases						8			2			
Actuated Green, G (s)	14.0	4.0		25.0		15.0		60.0	60.0	20.0	84.0	
Effective Green, g (s)	14.0	4.0		25.0		15.0		60.0	60.0	20.0	84.0	
Actuated g/C Ratio	0.11	0.03		0.20		0.12		0.48	0.48	0.16	0.67	
Clearance Time (s)	4.0	4.0		4.0		4.0		4.0	4.0	4.0	4.0	
Lane Grp Cap (vph)	191	52		341		322		2349	732	528	3288	
v/s Ratio Prot	0.01	0.00		c0.16				c0.40		0.12	c0.53	
v/s Ratio Perm						c0.03			0.05			
v/c Ratio	0.06	0.10		0.79		0.22		0.82	0.10	0.76	0.79	
Uniform Delay, d1	49.6	58.8		47.5		49.7		28.0	17.8	50.2	14.3	
Progression Factor	1.00	1.00		1.00		1.00		1.00	1.00	1.00	1.00	
Incremental Delay, d2	0.6	3.9		16.5		1.6		3.5	0.3	9.8	2.0	
Delay (s)	50.2	62.7		64.0		51.3		31.4	18.0	60.0	16.4	
Level of Service	D	E		E		D		C	B	E	B	
Approach Delay (s)		57.4			55.3			30.9			22.2	
Approach LOS		E			E			C			C	
Intersection Summary												
HCM Average Control Delay			30.1				HCM Level of Service			C		
HCM Volume to Capacity ratio			0.77									
Actuated Cycle Length (s)			125.0				Sum of lost time (s)		12.0			
Intersection Capacity Utilization			77.5%				ICU Level of Service			D		
Analysis Period (min)			15									

c Critical Lane Group

Lanes, Volumes, Timings
7: Pioneer Park & KY 17 Madison Pike

8/31/2006

Lane Group	EBL	EBT	EBR	WBL	WBT	WBR	NBL	NBT	NBR	SBL	SBT	SBR
Lane Configurations												
Ideal Flow (vphpl)	1900	1900	1900	1900	1900	1900	1900	1900	1900	1900	1900	1900
Storage Length (ft)	50		50	400		150	550		50	300		0
Storage Lanes	1		0	1		1	0		1	2		0
Total Lost Time (s)	4.0	4.0	4.0	4.0	4.0	4.0	4.0	4.0	4.0	4.0	4.0	4.0
Turning Speed (mph)	15		9	15		9	15		9	15		9
Lane Util. Factor	1.00	1.00	1.00	1.00	1.00	0.88	1.00	0.91	1.00	0.97	0.91	1.00
Fr _t		0.900				0.850			0.850			
Fl _t Protected	0.950			0.950						0.950		
Satd. Flow (prot)	1703	1613	0	1703	0	2682	0	4893	1524	3303	4893	0
Fl _t Permitted	0.950			0.950						0.950		
Satd. Flow (perm)	1703	1613	0	1703	0	2682	0	4893	1524	3303	4893	0
Right Turn on Red			Yes			Yes			Yes			Yes
Satd. Flow (RTOR)		10				589			20			
Headway Factor	1.00	1.00	1.00	1.00	1.00	1.00	1.00	1.00	1.00	1.00	1.00	1.00
Link Speed (mph)		25				35			55			55
Link Distance (ft)		280				543			1720			1351
Travel Time (s)		7.6				10.6			21.3			16.7
Volume (vph)	10	5	10	260	0	560	0	1840	80	380	2520	0
Peak Hour Factor	0.95	0.95	0.97	0.97	0.95	0.95	0.95	0.95	0.95	0.95	0.97	0.95
Adj. Flow (vph)	11	5	10	268	0	589	0	1937	84	400	2598	0
Lane Group Flow (vph)	11	15	0	268	0	589	0	1937	84	400	2598	0
Turn Type	Prot			Prot		custom			Perm	Prot		
Protected Phases	7	4		3				2		1		6
Permitted Phases						8			2			
Minimum Split (s)	8.0	8.0		8.0		30.0		30.0	30.0	8.0		30.0
Total Split (s)	18.0	8.0	0.0	29.0	0.0	19.0	0.0	64.0	64.0	24.0	88.0	0.0
Total Split (%)	14.4%	6.4%	0.0%	23.2%	0.0%	15.2%	0.0%	51.2%	51.2%	19.2%	70.4%	0.0%
Maximum Green (s)	14.0	4.0		25.0		15.0		60.0	60.0	20.0	84.0	
Yellow Time (s)	3.0	3.0		3.0		3.0		3.0	3.0	3.0	3.0	
All-Red Time (s)	1.0	1.0		1.0		1.0		1.0	1.0	1.0	1.0	
Lead/Lag	Lead	Lag		Lead		Lag		Lag	Lag	Lead		
Lead-Lag Optimize?	Yes	Yes		Yes		Yes		Yes	Yes	Yes		
Walk Time (s)		5.0				5.0		5.0	5.0			5.0
Flash Dont Walk (s)		11.0				11.0		11.0	11.0			11.0
Pedestrian Calls (#/hr)		0				0		0	0			0
Act Effct Green (s)	14.0	4.0		25.0		15.0		60.0	60.0	20.0	84.0	
Actuated g/C Ratio	0.11	0.03		0.20		0.12		0.48	0.48	0.16	0.67	
v/c Ratio	0.06	0.25		0.79		0.70		0.82	0.11	0.76	0.79	
Control Delay	50.6	45.6		64.7		9.0		31.8	14.0	60.4	16.6	
Queue Delay	0.0	0.0		0.0		0.0		0.0	0.0	0.0	0.0	
Total Delay	50.6	45.6		64.7		9.0		31.8	14.0	60.4	16.6	
LOS	D	D		E		A		C	B	E	B	
Approach Delay		47.7						31.0			22.5	
Approach LOS		D						C			C	
Queue Length 50th (ft)	8	4		208		0		481	27	161	494	
Queue Length 95th (ft)	27	28		#339		57		548	58	218	556	
Internal Link Dist (ft)		200				463		1640			1271	
Turn Bay Length (ft)	50			400		150			50	300		

Lanes, Volumes, Timings
 7: Pioneer Park & KY 17 Madison Pike

8/31/2006



Lane Group	EBL	EBT	EBR	WBL	WBT	WBR	NBL	NBT	NBR	SBL	SBT	SBR
Base Capacity (vph)	191	61		341		840		2349	742	528	3288	
Starvation Cap Reductn	0	0		0		0		0	0	0	0	
Spillback Cap Reductn	0	0		0		0		0	0	0	0	
Storage Cap Reductn	0	0		0		0		0	0	0	0	
Reduced v/c Ratio	0.06	0.25		0.79		0.70		0.82	0.11	0.76	0.79	

Intersection Summary

Area Type: Other
 Cycle Length: 125
 Actuated Cycle Length: 125
 Offset: 0 (0%), Referenced to phase 2:NBT and 6:SBT, Start of Green
 Natural Cycle: 90
 Control Type: Pretimed
 Maximum v/c Ratio: 0.82
 Intersection Signal Delay: 26.1 Intersection LOS: C
 Intersection Capacity Utilization 77.5% ICU Level of Service D
 Analysis Period (min) 15
 # 95th percentile volume exceeds capacity, queue may be longer.
 Queue shown is maximum after two cycles.

Splits and Phases: 7: Pioneer Park & KY 17 Madison Pike



HCM Unsignalized Intersection Capacity Analysis
 3: Old KY 17 & KY 17 Madison Pike

8/31/2006



Movement	EBL	EBR	NBL	NBT	SBT	SBR
Lane Configurations						
Sign Control	Stop			Free	Free	
Grade	0%			0%	0%	
Volume (veh/h)	40	10	10	3360	940	60
Peak Hour Factor	1.00	0.95	0.95	1.00	0.95	0.95
Hourly flow rate (vph)	40	11	11	3360	989	63
Pedestrians						
Lane Width (ft)						
Walking Speed (ft/s)						
Percent Blockage						
Right turn flare (veh)						
Median type	TWLTL					
Median storage (veh)	0					
Upstream signal (ft)						
pX, platoon unblocked						
vC, conflicting volume	2722	526	1053			
vC1, stage 1 conf vol	1021					
vC2, stage 2 conf vol	1701					
vCu, unblocked vol	2722	526	1053			
tC, single (s)	6.9	7.0	4.2			
tC, 2 stage (s)	5.9					
tF (s)	3.6	3.4	2.3			
p0 queue free %	38	98	98			
cM capacity (veh/h)	64	486	634			

Direction, Lane #	EB 1	NB 1	NB 2	NB 3	SB 1	SB 2
Volume Total	51	11	1680	1680	660	393
Volume Left	40	11	0	0	0	0
Volume Right	11	0	0	0	0	63
cSH	79	634	1700	1700	1700	1700
Volume to Capacity	0.64	0.02	0.99	0.99	0.39	0.23
Queue Length 95th (ft)	74	1	0	0	0	0
Control Delay (s)	111.0	10.8	0.0	0.0	0.0	0.0
Lane LOS	F	B				
Approach Delay (s)	111.0	0.0	0.0			
Approach LOS	F					

Intersection Summary						
Average Delay			1.3			
Intersection Capacity Utilization	102.9%		ICU Level of Service	G		
Analysis Period (min)			15			

HCM Unsignalized Intersection Capacity Analysis
 3: Old KY 17 & KY 17 Madison Pike

8/31/2006



Movement	EBL	EBT	EBR	WBL	WBT	WBR	NBL	NBT	NBR	SBL	SBT	SBR
Lane Configurations		↕			↕		↗	↕			↕	
Sign Control		Stop			Stop			Free			Free	
Grade		0%			0%			0%			0%	
Volume (veh/h)	95	5	30	40	5	95	30	3210	90	45	1610	145
Peak Hour Factor	1.00	0.95	0.95	0.95	0.95	1.00	0.95	1.00	0.95	0.95	0.95	0.95
Hourly flow rate (vph)	95	5	32	42	5	95	32	3210	95	47	1695	153
Pedestrians												
Lane Width (ft)												
Walking Speed (ft/s)												
Percent Blockage												
Right turn flare (veh)												
Median type		Raised			Raised							
Median storage veh		0			0							
Upstream signal (ft)												
pX, platoon unblocked												
vC, conflicting volume	3632	5234	924	4297	5263	1652	1847			3305		
vC1, stage 1 conf vol	1866	1866		3321	3321							
vC2, stage 2 conf vol	1766	3368		976	1942							
vCu, unblocked vol	3632	5234	924	4297	5263	1652	1847			3305		
tC, single (s)	7.6	6.6	7.0	7.6	6.6	7.0	4.2			4.2		
tC, 2 stage (s)	6.6	5.6		6.6	5.6							
tF (s)	3.6	4.1	3.4	3.6	4.1	3.4	2.3			2.3		
p0 queue free %	0	0	88	0	0	0	90			40		
cM capacity (veh/h)	0	0	264	4	4	84	309			79		

Direction, Lane #	EB 1	WB 1	NB 1	NB 2	NB 3	SB 1	SB 2
Volume Total	132	142	32	2140	1165	895	1000
Volume Left	95	42	32	0	0	47	0
Volume Right	32	95	0	0	95	0	153
cSH	0	11	309	1700	1700	79	1700
Volume to Capacity	Err	12.55	0.10	1.26	0.69	0.60	0.59
Queue Length 95th (ft)	Err	Err	8	0	0	67	0
Control Delay (s)	Err	Err	18.0	0.0	0.0	124.5	0.0
Lane LOS	F	F	C			F	
Approach Delay (s)	Err	Err	0.2			58.8	
Approach LOS	F	F					

Intersection Summary			
Average Delay		Err	
Intersection Capacity Utilization	112.3%	ICU Level of Service	H
Analysis Period (min)	15		

HCM Signalized Intersection Capacity Analysis
 3: Old KY 17 & KY 17 Madison Pike

8/31/2006



Movement	EBL	EBT	EBR	WBL	WBT	WBR	NBL	NBT	NBR	SBL	SBT	SBR
Lane Configurations		↕			↕		↗	↕		↗	↕	↗
Ideal Flow (vphpl)	1900	1900	1900	1900	1900	1900	1900	1900	1900	1900	1900	1900
Total Lost time (s)		4.0			4.0		4.0	4.0		4.0	4.0	
Lane Util. Factor		1.00			1.00		1.00	0.95		1.00	0.95	
Frt		0.97			0.91		1.00	1.00		1.00	0.99	
Flt Protected		0.97			0.99		0.95	1.00		0.95	1.00	
Satd. Flow (prot)		1674			1607		1703	3391		1703	3363	
Flt Permitted		0.57			0.89		0.07	1.00		0.04	1.00	
Satd. Flow (perm)		989			1449		124	3391		81	3363	
Volume (vph)	95	5	30	40	5	95	30	3210	90	45	1610	145
Peak-hour factor, PHF	1.00	0.95	0.95	0.95	0.95	1.00	0.95	1.00	0.95	0.95	0.95	0.95
Adj. Flow (vph)	95	5	32	42	5	95	32	3210	95	47	1695	153
RTOR Reduction (vph)	0	9	0	0	41	0	0	2	0	0	5	0
Lane Group Flow (vph)	0	123	0	0	101	0	32	3303	0	47	1843	0
Turn Type	Perm		Perm			pm+pt		pm+pt				
Protected Phases	4		8			5		2		1		6
Permitted Phases	4		8			2		6				
Actuated Green, G (s)	20.0		20.0			93.0		89.0		93.0		89.0
Effective Green, g (s)	20.0		20.0			93.0		89.0		93.0		89.0
Actuated g/C Ratio	0.16		0.16			0.74		0.71		0.74		0.71
Clearance Time (s)	4.0		4.0			4.0		4.0		4.0		4.0
Lane Grp Cap (vph)	158		232			143		2414		112		2394
v/s Ratio Prot						0.01		c0.97		c0.01		0.55
v/s Ratio Perm	c0.12		0.07			0.16		0.30				
v/c Ratio	0.78		0.43			0.22		1.37		0.42		0.77
Uniform Delay, d1	50.4		47.4			11.1		18.0		60.2		11.5
Progression Factor	1.00		1.00			1.00		1.00		1.00		1.00
Incremental Delay, d2	30.4		5.8			3.6		168.5		11.1		2.5
Delay (s)	80.8		53.2			14.7		186.5		71.4		13.9
Level of Service	F		D			B		F		E		B
Approach Delay (s)	80.8		53.2			184.8		15.3				
Approach LOS	F		D			F		B				

Intersection Summary			
HCM Average Control Delay	120.6	HCM Level of Service	F
HCM Volume to Capacity ratio	1.23		
Actuated Cycle Length (s)	125.0	Sum of lost time (s)	12.0
Intersection Capacity Utilization	112.3%	ICU Level of Service	H
Analysis Period (min)	15		

c Critical Lane Group

Lanes, Volumes, Timings
 3: Old KY 17 & KY 17 Madison Pike

8/31/2006



Lane Group	EBL	EBT	EBR	WBL	WBT	WBR	NBL	NBT	NBR	SBL	SBT	SBR
Lane Configurations		↕			↕		↗	↕↗		↗	↕↗	
Ideal Flow (vphpl)	1900	1900	1900	1900	1900	1900	1900	1900	1900	1900	1900	1900
Storage Length (ft)	0		0	0		0	200		0	0		0
Storage Lanes	0		0	0		0	1		0	1		0
Total Lost Time (s)	4.0	4.0	4.0	4.0	4.0	4.0	4.0	4.0	4.0	4.0	4.0	4.0
Turning Speed (mph)	15		9	15		9	15		9	15		9
Lane Util. Factor	1.00	1.00	1.00	1.00	1.00	1.00	1.00	0.95	0.95	1.00	0.95	0.95
Fr _t		0.967			0.910			0.996			0.988	
Fl _t Protected		0.965			0.985		0.950			0.950		
Satd. Flow (prot)	0	1673	0	0	1607	0	1703	3392	0	1703	3365	0
Fl _t Permitted		0.570			0.889		0.069			0.045		
Satd. Flow (perm)	0	988	0	0	1450	0	124	3392	0	81	3365	0
Right Turn on Red			Yes			Yes			Yes			Yes
Satd. Flow (RTOR)		11			49			6			19	
Headway Factor	1.00	1.00	1.00	1.00	1.00	1.00	1.00	1.00	1.00	1.00	1.00	1.00
Link Speed (mph)		25			25			55			55	
Link Distance (ft)		1049			589			1157			934	
Travel Time (s)		28.6			16.1			14.3			11.6	
Volume (vph)	95	5	30	40	5	95	30	3210	90	45	1610	145
Peak Hour Factor	1.00	0.95	0.95	0.95	0.95	1.00	0.95	1.00	0.95	0.95	0.95	0.95
Adj. Flow (vph)	95	5	32	42	5	95	32	3210	95	47	1695	153
Lane Group Flow (vph)	0	132	0	0	142	0	32	3305	0	47	1848	0
Turn Type	Perm			Perm			pm+pt			pm+pt		
Protected Phases		4			8		5	2		1	6	
Permitted Phases	4			8			2			6		
Minimum Split (s)	20.0	20.0		20.0	20.0		8.0	20.0		8.0	20.0	
Total Split (s)	24.0	24.0	0.0	24.0	24.0	0.0	8.0	93.0	0.0	8.0	93.0	0.0
Total Split (%)	19.2%	19.2%	0.0%	19.2%	19.2%	0.0%	6.4%	74.4%	0.0%	6.4%	74.4%	0.0%
Maximum Green (s)	20.0	20.0		20.0	20.0		4.0	89.0		4.0	89.0	
Yellow Time (s)	3.5	3.5		3.5	3.5		3.5	3.5		3.5	3.5	
All-Red Time (s)	0.5	0.5		0.5	0.5		0.5	0.5		0.5	0.5	
Lead/Lag							Lead	Lag		Lead	Lag	
Lead-Lag Optimize?							Yes	Yes		Yes	Yes	
Walk Time (s)	5.0	5.0		5.0	5.0			5.0			5.0	
Flash Dont Walk (s)	11.0	11.0		11.0	11.0			11.0			11.0	
Pedestrian Calls (#/hr)	0	0		0	0			0			0	
Act Effct Green (s)		20.0			20.0		93.0	89.0		93.0	89.0	
Actuated g/C Ratio		0.16			0.16		0.74	0.71		0.74	0.71	
v/c Ratio		0.79			0.52		0.22	1.37		0.42	0.77	
Control Delay		77.9			38.7		6.9	189.4		19.0	14.1	
Queue Delay		0.0			0.0		0.0	0.0		0.0	0.0	
Total Delay		77.9			38.7		6.9	189.4		19.0	14.1	
LOS		E			D		A	F		B	B	
Approach Delay		77.9			38.7			187.7			14.3	
Approach LOS		E			D			F			B	
Queue Length 50th (ft)		96			69		5	~1867		7	444	
Queue Length 95th (ft)		#206			138		12	#1981		29	538	
Internal Link Dist (ft)		969			509			1077			854	
Turn Bay Length (ft)							200					

Lanes, Volumes, Timings
 3: Old KY 17 & KY 17 Madison Pike

8/31/2006



Lane Group	EBL	EBT	EBR	WBL	WBT	WBR	NBL	NBT	NBR	SBL	SBT	SBR
Base Capacity (vph)		167			273		143	2417		112	2401	
Starvation Cap Reductn		0			0		0	0		0	0	
Spillback Cap Reductn		0			0		0	0		0	0	
Storage Cap Reductn		0			0		0	0		0	0	
Reduced v/c Ratio		0.79			0.52		0.22	1.37		0.42	0.77	

Intersection Summary

Area Type: Other
 Cycle Length: 125
 Actuated Cycle Length: 125
 Offset: 7 (6%), Referenced to phase 2:NBTL and 6:SBTL, Start of Green
 Natural Cycle: 150
 Control Type: Pretimed
 Maximum v/c Ratio: 1.37
 Intersection Signal Delay: 121.5 Intersection LOS: F
 Intersection Capacity Utilization 112.3% ICU Level of Service H
 Analysis Period (min) 15
 ~ Volume exceeds capacity, queue is theoretically infinite.
 Queue shown is maximum after two cycles.
 # 95th percentile volume exceeds capacity, queue may be longer.
 Queue shown is maximum after two cycles.

Splits and Phases: 3: Old KY 17 & KY 17 Madison Pike

8 s	93 s	24 s	8 s	93 s	24 s

HCM Signalized Intersection Capacity Analysis

3: Old KY 17 & KY 17 Madison Pike

8/31/2006

Movement	EBL	EBT	EBR	WBL	WBT	WBR	NBL	NBT	NBR	SBL	SBT	SBR
Lane Configurations												
Ideal Flow (vphpl)	1900	1900	1900	1900	1900	1900	1900	1900	1900	1900	1900	1900
Total Lost time (s)	4.0	4.0		4.0	4.0		4.0	4.0		4.0	4.0	
Lane Util. Factor	1.00	1.00		1.00	1.00		1.00	0.91		1.00	0.91	
Frt	1.00	0.87		1.00	0.86		1.00	1.00		1.00	0.99	
Flt Protected	0.95	1.00		0.95	1.00		0.95	1.00		0.95	1.00	
Satd. Flow (prot)	1703	1560		1703	1537		1703	4872		1703	4833	
Flt Permitted	1.00	1.00		1.00	1.00		0.95	1.00		0.95	1.00	
Satd. Flow (perm)	1792	1560		1792	1537		1703	4872		1703	4833	
Volume (vph)	95	5	30	40	5	95	30	3210	90	45	1610	145
Peak-hour factor, PHF	1.00	0.95	0.95	0.95	0.95	1.00	0.95	1.00	0.95	0.95	0.95	0.95
Adj. Flow (vph)	95	5	32	42	5	95	32	3210	95	47	1695	153
RTOR Reduction (vph)	0	31	0	0	92	0	0	3	0	0	8	0
Lane Group Flow (vph)	95	6	0	42	8	0	32	3302	0	47	1840	0
Turn Type	pm+pt		pm+pt		Prot		Prot					
Protected Phases	7	4		3	8		5	2		1	6	
Permitted Phases	4		8									
Actuated Green, G (s)	12.0	4.0		12.0	4.0		8.0	89.0		8.0	89.0	
Effective Green, g (s)	12.0	4.0		12.0	4.0		8.0	89.0		8.0	89.0	
Actuated g/C Ratio	0.10	0.03		0.10	0.03		0.06	0.71		0.06	0.71	
Clearance Time (s)	4.0	4.0		4.0	4.0		4.0	4.0		4.0	4.0	
Lane Grp Cap (vph)	166	50		166	49		109	3469		109	3441	
v/s Ratio Prot	c0.04	0.00		0.02	0.01		0.02	c0.68		c0.03	0.38	
v/s Ratio Perm	c0.02		0.01									
v/c Ratio	0.57	0.12		0.25	0.16		0.29	0.95		0.43	0.53	
Uniform Delay, d1	54.1	58.8		52.4	58.9		55.8	16.1		56.3	8.4	
Progression Factor	1.00	1.00		1.00	1.00		1.00	1.00		1.00	1.00	
Incremental Delay, d2	13.6	4.9		3.6	7.1		6.7	7.6		12.0	0.6	
Delay (s)	67.7	63.7		56.0	66.0		62.5	23.7		68.3	9.0	
Level of Service	E	E		E	E		E	C		E	A	
Approach Delay (s)	66.6		63.0				24.1				10.4	
Approach LOS	E		E				C				B	
Intersection Summary												
HCM Average Control Delay			21.4		HCM Level of Service						C	
HCM Volume to Capacity ratio			0.87									
Actuated Cycle Length (s)			125.0		Sum of lost time (s)						16.0	
Intersection Capacity Utilization			82.6%		ICU Level of Service						E	
Analysis Period (min)			15									

c Critical Lane Group

Lanes, Volumes, Timings
 3: Old KY 17 & KY 17 Madison Pike

8/31/2006



Lane Group	EBL	EBT	EBR	WBL	WBT	WBR	NBL	NBT	NBR	SBL	SBT	SBR
Lane Configurations	↖	↗		↖	↗		↖	↑↑↑		↖	↑↑↑	
Ideal Flow (vphpl)	1900	1900	1900	1900	1900	1900	1900	1900	1900	1900	1900	1900
Storage Length (ft)	0		0	0		0	200		0	60		0
Storage Lanes	1		0	1		0	1		0	1		0
Total Lost Time (s)	4.0	4.0	4.0	4.0	4.0	4.0	4.0	4.0	4.0	4.0	4.0	4.0
Turning Speed (mph)	15		9	15		9	15		9	15		9
Lane Util. Factor	1.00	1.00	1.00	1.00	1.00	1.00	1.00	0.91	0.91	1.00	0.91	0.91
Fr _t		0.870			0.858			0.996			0.988	
Fl _t Protected	0.950			0.950			0.950			0.950		
Satd. Flow (prot)	1703	1559	0	1703	1538	0	1703	4874	0	1703	4835	0
Fl _t Permitted							0.950			0.950		
Satd. Flow (perm)	1792	1559	0	1792	1538	0	1703	4874	0	1703	4835	0
Right Turn on Red			Yes			Yes			Yes			Yes
Satd. Flow (RTOR)		32			95			9			29	
Headway Factor	1.00	1.00	1.00	1.00	1.00	1.00	1.00	1.00	1.00	1.00	1.00	1.00
Link Speed (mph)		25			25			55			55	
Link Distance (ft)		1049			589			1157			934	
Travel Time (s)		28.6			16.1			14.3			11.6	
Volume (vph)	95	5	30	40	5	95	30	3210	90	45	1610	145
Peak Hour Factor	1.00	0.95	0.95	0.95	0.95	1.00	0.95	1.00	0.95	0.95	0.95	0.95
Adj. Flow (vph)	95	5	32	42	5	95	32	3210	95	47	1695	153
Lane Group Flow (vph)	95	37	0	42	100	0	32	3305	0	47	1848	0
Turn Type	pm+pt			pm+pt			Prot			Prot		
Protected Phases	7	4		3	8		5	2		1	6	
Permitted Phases	4			8								
Minimum Split (s)	8.0	20.0		8.0	20.0		8.0	20.0		8.0	20.0	
Total Split (s)	12.0	8.0	0.0	12.0	8.0	0.0	12.0	93.0	0.0	12.0	93.0	0.0
Total Split (%)	9.6%	6.4%	0.0%	9.6%	6.4%	0.0%	9.6%	74.4%	0.0%	9.6%	74.4%	0.0%
Maximum Green (s)	8.0	4.0		8.0	4.0		8.0	89.0		8.0	89.0	
Yellow Time (s)	3.0	3.0		3.0	3.0		3.0	3.0		3.0	3.0	
All-Red Time (s)	1.0	1.0		1.0	1.0		1.0	1.0		1.0	1.0	
Lead/Lag	Lead	Lag		Lead	Lag		Lead	Lag		Lead	Lag	
Lead-Lag Optimize?	Yes	Yes		Yes	Yes		Yes	Yes		Yes	Yes	
Walk Time (s)		5.0			5.0			5.0			5.0	
Flash Dont Walk (s)		11.0			11.0			11.0			11.0	
Pedestrian Calls (#/hr)		0			0			0			0	
Act Effct Green (s)	12.0	4.0		12.0	4.0		8.0	89.0		8.0	89.0	
Actuated g/C Ratio	0.10	0.03		0.10	0.03		0.06	0.71		0.06	0.71	
v/c Ratio	0.57	0.46		0.25	0.71		0.29	0.95		0.43	0.54	
Control Delay	65.1	40.8		53.0	39.4		63.2	24.1		69.0	8.9	
Queue Delay	0.0	0.0		0.0	0.0		0.0	0.0		0.0	0.0	
Total Delay	65.1	40.8		53.0	39.4		63.2	24.1		69.0	8.9	
LOS	E	D		D	D		E	C		E	A	
Approach Delay		58.3			43.5			24.5			10.4	
Approach LOS		E			D			C			B	
Queue Length 50th (ft)	72	4		31	4		25	782		37	224	
Queue Length 95th (ft)	128	#42		67	#86		60	883		79	257	
Internal Link Dist (ft)		969			509			1077			854	
Turn Bay Length (ft)							200			60		

Lanes, Volumes, Timings
 3: Old KY 17 & KY 17 Madison Pike

8/31/2006



Lane Group	EBL	EBT	EBR	WBL	WBT	WBR	NBL	NBT	NBR	SBL	SBT	SBR
Base Capacity (vph)	166	81		166	141		109	3473		109	3451	
Starvation Cap Reductn	0	0		0	0		0	0		0	0	
Spillback Cap Reductn	0	0		0	0		0	0		0	0	
Storage Cap Reductn	0	0		0	0		0	0		0	0	
Reduced v/c Ratio	0.57	0.46		0.25	0.71		0.29	0.95		0.43	0.54	

Intersection Summary

Area Type:	Other
Cycle Length:	125
Actuated Cycle Length:	125
Offset:	124 (99%), Referenced to phase 2:NBT and 6:SBT, Start of Green
Natural Cycle:	120
Control Type:	Pretimed
Maximum v/c Ratio:	0.95
Intersection Signal Delay:	20.9
Intersection LOS:	C
Intersection Capacity Utilization	82.6%
ICU Level of Service	E
Analysis Period (min)	15
# 95th percentile volume exceeds capacity, queue may be longer. Queue shown is maximum after two cycles.	

Splits and Phases: 3: Old KY 17 & KY 17 Madison Pike

04	01	02	03	07
12 s	93 s		12 s	8 s
05	06		07	08
12 s	93 s		12 s	8 s

HCM Unsignalized Intersection Capacity Analysis
 3: Old KY 17 & KY 17 Madison Pike

8/31/2006



Movement	EBL	EBR	NBL	NBT	SBT	SBR
Lane Configurations						
Sign Control	Stop			Free	Free	
Grade	0%			0%	0%	
Volume (veh/h)	60	10	10	1400	2660	60
Peak Hour Factor	0.95	0.95	0.95	0.95	0.95	0.95
Hourly flow rate (vph)	63	11	11	1474	2800	63
Pedestrians						
Lane Width (ft)						
Walking Speed (ft/s)						
Percent Blockage						
Right turn flare (veh)						
Median type	TWLTL					
Median storage veh	0					
Upstream signal (ft)						
pX, platoon unblocked						
vC, conflicting volume	3589	1432	2863			
vC1, stage 1 conf vol	2832					
vC2, stage 2 conf vol	758					
vCu, unblocked vol	3589	1432	2863			
tC, single (s)	6.9	7.0	4.2			
tC, 2 stage (s)	5.9					
tF (s)	3.6	3.4	2.3			
p0 queue free %	0	91	91			
cM capacity (veh/h)	18	119	120			
Direction, Lane #	EB 1	NB 1	NB 2	NB 3	SB 1	SB 2
Volume Total	74	11	737	737	1867	996
Volume Left	63	11	0	0	0	0
Volume Right	11	0	0	0	0	63
cSH	21	120	1700	1700	1700	1700
Volume to Capacity	3.52	0.09	0.43	0.43	1.10	0.59
Queue Length 95th (ft)	Err	7	0	0	0	0
Control Delay (s)	Err	38.0	0.0	0.0	0.0	0.0
Lane LOS	F	E				
Approach Delay (s)	Err	0.3			0.0	
Approach LOS	F					
Intersection Summary						
Average Delay		166.7				
Intersection Capacity Utilization		86.0%		ICU Level of Service	E	
Analysis Period (min)		15				

HCM Unsignalized Intersection Capacity Analysis
 3: Old KY 17 & KY 17 Madison Pike

8/31/2006



Movement	EBL	EBT	EBR	WBL	WBT	WBR	NBL	NBT	NBR	SBL	SBT	SBR
Lane Configurations		↕			↕		↗	↕			↕	
Sign Control		Stop			Stop			Free			Free	
Grade		0%			0%			0%			0%	
Volume (veh/h)	165	5	40	65	5	65	40	2400	60	70	2665	165
Peak Hour Factor	0.95	0.95	0.96	0.96	0.95	0.95	0.95	0.95	0.95	0.95	0.96	0.95
Hourly flow rate (vph)	174	5	42	68	5	68	42	2526	63	74	2776	174
Pedestrians												
Lane Width (ft)												
Walking Speed (ft/s)												
Percent Blockage												
Right turn flare (veh)												
Median type		Raised			Raised							
Median storage veh		0			0							
Upstream signal (ft)												
pX, platoon unblocked												
vC, conflicting volume	4429	5684	1475	4222	5739	1295	2950			2589		
vC1, stage 1 conf vol	3010	3010		2642	2642							
vC2, stage 2 conf vol	1418	2674		1580	3097							
vCu, unblocked vol	4429	5684	1475	4222	5739	1295	2950			2589		
tC, single (s)	7.6	6.6	7.0	7.6	6.6	7.0	4.2			4.2		
tC, 2 stage (s)	6.6	5.6		6.6	5.6							
tF (s)	3.6	4.1	3.4	3.6	4.1	3.4	2.3			2.3		
p0 queue free %	0	0	63	0	0	54	62			52		
cM capacity (veh/h)	0	0	111	0	0	148	110			155		
Direction, Lane #	EB 1	WB 1	NB 1	NB 2	NB 3	SB 1	SB 2					
Volume Total	221	141	42	1684	905	1462	1562					
Volume Left	174	68	42	0	0	74	0					
Volume Right	42	68	0	0	63	0	174					
cSH	0	0	110	1700	1700	155	1700					
Volume to Capacity	Err	Err	0.38	0.99	0.53	0.48	0.92					
Queue Length 95th (ft)	Err	Err	39	0	0	56	0					
Control Delay (s)	Err	Err	56.6	0.0	0.0	119.8	0.0					
Lane LOS	F	F	F			F						
Approach Delay (s)	Err	Err	0.9			57.9						
Approach LOS	F	F										
Intersection Summary												
Average Delay			Err									
Intersection Capacity Utilization			154.7%			ICU Level of Service				H		
Analysis Period (min)			15									

HCM Signalized Intersection Capacity Analysis
 3: Old KY 17 & KY 17 Madison Pike

8/31/2006



Movement	EBL	EBT	EBR	WBL	WBT	WBR	NBL	NBT	NBR	SBL	SBT	SBR
Lane Configurations		↕			↕		↗	↕		↗	↕	
Ideal Flow (vphpl)	1900	1900	1900	1900	1900	1900	1900	1900	1900	1900	1900	1900
Total Lost time (s)		4.0			4.0		4.0	4.0		4.0	4.0	
Lane Util. Factor		1.00			1.00		1.00	0.95		1.00	0.95	
Frt		0.97			0.93		1.00	1.00		1.00	0.99	
Flt Protected		0.96			0.98		0.95	1.00		0.95	1.00	
Satd. Flow (prot)		1680			1636		1703	3393		1703	3376	
Flt Permitted		0.62			0.86		0.04	1.00		0.04	1.00	
Satd. Flow (perm)		1079			1442		81	3393		80	3376	
Volume (vph)	165	5	40	65	5	65	40	2400	60	70	2665	165
Peak-hour factor, PHF	0.95	0.95	0.96	0.96	0.95	0.95	0.95	0.95	0.95	0.95	0.96	0.95
Adj. Flow (vph)	174	5	42	68	5	68	42	2526	63	74	2776	174
RTOR Reduction (vph)	0	7	0	0	27	0	0	1	0	0	4	0
Lane Group Flow (vph)	0	214	0	0	114	0	42	2588	0	74	2946	0
Turn Type	Perm		Perm			pm+pt		pm+pt				
Protected Phases	4		8			5		2		1		6
Permitted Phases	4		8			2		6				
Actuated Green, G (s)	19.0		19.0			93.0		89.0		95.0		90.0
Effective Green, g (s)	19.0		19.0			93.0		89.0		95.0		90.0
Actuated g/C Ratio	0.15		0.15			0.74		0.71		0.76		0.72
Clearance Time (s)	4.0		4.0			4.0		4.0		4.0		4.0
Lane Grp Cap (vph)	164		219			112		2416		126		2431
v/s Ratio Prot						0.01		0.76		c0.02		c0.87
v/s Ratio Perm	c0.20		0.08			0.27		0.43				
v/c Ratio	1.31		0.52			0.38		1.07		0.59		1.21
Uniform Delay, d1	53.0		48.8			60.0		18.0		60.2		17.5
Progression Factor	1.00		1.00			1.00		1.00		1.00		1.00
Incremental Delay, d2	174.7		8.6			9.3		40.8		18.5		99.5
Delay (s)	227.7		57.4			69.4		58.8		78.7		117.0
Level of Service	F		E			E		E		E		F
Approach Delay (s)	227.7		57.4					58.9				116.0
Approach LOS	F		E					E				F

Intersection Summary

HCM Average Control Delay	93.8	HCM Level of Service	F
HCM Volume to Capacity ratio	1.17		
Actuated Cycle Length (s)	125.0	Sum of lost time (s)	8.0
Intersection Capacity Utilization	104.1%	ICU Level of Service	G
Analysis Period (min)	15		

c Critical Lane Group

Lanes, Volumes, Timings
3: Old KY 17 & KY 17 Madison Pike

8/31/2006



Lane Group	EBL	EBT	EBR	WBL	WBT	WBR	NBL	NBT	NBR	SBL	SBT	SBR
Lane Configurations		↕			↕		↕	↕↗		↕	↕↗	
Ideal Flow (vphpl)	1900	1900	1900	1900	1900	1900	1900	1900	1900	1900	1900	1900
Storage Length (ft)	0		0	0		0	200		0	200		0
Storage Lanes	0		0	0		0	1		0	1		0
Total Lost Time (s)	4.0	4.0	4.0	4.0	4.0	4.0	4.0	4.0	4.0	4.0	4.0	4.0
Turning Speed (mph)	15		9	15		9	15		9	15		9
Lane Util. Factor	1.00	1.00	1.00	1.00	1.00	1.00	1.00	0.95	0.95	1.00	0.95	0.95
Fr _t		0.974			0.935			0.996			0.991	
Fl _t Protected		0.962			0.976		0.950			0.950		
Satd. Flow (prot)	0	1680	0	0	1636	0	1703	3392	0	1703	3375	0
Fl _t Permitted		0.618			0.861		0.045			0.044		
Satd. Flow (perm)	0	1079	0	0	1443	0	81	3392	0	79	3375	0
Right Turn on Red			Yes			Yes			Yes			Yes
Satd. Flow (RTOR)		8			32			5			13	
Headway Factor	1.00	1.00	1.00	1.00	1.00	1.00	1.00	1.00	1.00	1.00	1.00	1.00
Link Speed (mph)		25			25			55			55	
Link Distance (ft)		1049			589			1157			934	
Travel Time (s)		28.6			16.1			14.3			11.6	
Volume (vph)	165	5	40	65	5	65	40	2400	60	70	2665	165
Peak Hour Factor	0.95	0.95	0.96	0.96	0.95	0.95	0.95	0.95	0.95	0.95	0.96	0.95
Adj. Flow (vph)	174	5	42	68	5	68	42	2526	63	74	2776	174
Lane Group Flow (vph)	0	221	0	0	141	0	42	2589	0	74	2950	0
Turn Type	Perm			Perm			pm+pt			pm+pt		
Protected Phases		4			8		5	2		1	6	
Permitted Phases	4			8			2			6		
Minimum Split (s)	20.0	20.0		20.0	20.0		8.0	20.0		8.0	20.0	
Total Split (s)	23.0	23.0	0.0	23.0	23.0	0.0	8.0	93.0	0.0	9.0	94.0	0.0
Total Split (%)	18.4%	18.4%	0.0%	18.4%	18.4%	0.0%	6.4%	74.4%	0.0%	7.2%	75.2%	0.0%
Maximum Green (s)	19.0	19.0		19.0	19.0		4.0	89.0		5.0	90.0	
Yellow Time (s)	3.5	3.5		3.5	3.5		3.5	3.5		3.5	3.5	
All-Red Time (s)	0.5	0.5		0.5	0.5		0.5	0.5		0.5	0.5	
Lead/Lag							Lead	Lag		Lead	Lag	
Lead-Lag Optimize?							Yes	Yes		Yes	Yes	
Walk Time (s)	5.0	5.0		5.0	5.0			5.0			5.0	
Flash Dont Walk (s)	11.0	11.0		11.0	11.0			11.0			11.0	
Pedestrian Calls (#/hr)	0	0		0	0			0			0	
Act Effct Green (s)		19.0			19.0		93.0	89.0		95.0	90.0	
Actuated g/C Ratio		0.15			0.15		0.74	0.71		0.76	0.72	
v/c Ratio		1.29			0.57		0.38	1.07		0.59	1.21	
Control Delay		208.8			47.9		16.0	60.3		34.6	120.0	
Queue Delay		0.0			0.0		0.0	0.0		0.0	0.0	
Total Delay		208.8			47.9		16.0	60.3		34.6	120.0	
LOS		F			D		B	E		C	F	
Approach Delay		208.8			47.9			59.6			117.9	
Approach LOS		F			D			E			F	
Queue Length 50th (ft)		~223			82		6	~1223		11	~1539	
Queue Length 95th (ft)		#388			153		22	#1354		#73	#1661	
Internal Link Dist (ft)		969			509			1077			854	
Turn Bay Length (ft)							200			200		

Lanes, Volumes, Timings
 3: Old KY 17 & KY 17 Madison Pike

8/31/2006



Lane Group	EBL	EBT	EBR	WBL	WBT	WBR	NBL	NBT	NBR	SBL	SBT	SBR
Base Capacity (vph)		171			246		112	2417		125	2434	
Starvation Cap Reductn		0			0		0	0		0	0	
Spillback Cap Reductn		0			0		0	0		0	0	
Storage Cap Reductn		0			0		0	0		0	0	
Reduced v/c Ratio		1.29			0.57		0.38	1.07		0.59	1.21	

Intersection Summary





















Area Type: Other
 Cycle Length: 125
 Actuated Cycle Length: 125
 Offset: 117 (94%), Referenced to phase 2:NBTL and 6:SBTL, Start of Green
 Natural Cycle: 150
 Control Type: Pretimed
 Maximum v/c Ratio: 1.29
 Intersection Signal Delay: 94.1 Intersection LOS: F
 Intersection Capacity Utilization 104.1% ICU Level of Service G
 Analysis Period (min) 15
 ~ Volume exceeds capacity, queue is theoretically infinite.
 Queue shown is maximum after two cycles.
 # 95th percentile volume exceeds capacity, queue may be longer.
 Queue shown is maximum after two cycles.

Splits and Phases: 3: Old KY 17 & KY 17 Madison Pike

ø1	ø2	ø4
9 s	93 s	23 s
ø5	ø6	ø8
8 s	94 s	23 s

HCM Signalized Intersection Capacity Analysis
 3: Old KY 17 & KY 17 Madison Pike

8/31/2006

												
Movement	EBL	EBT	EBR	WBL	WBT	WBR	NBL	NBT	NBR	SBL	SBT	SBR
Lane Configurations												
Ideal Flow (vphpl)	1900	1900	1900	1900	1900	1900	1900	1900	1900	1900	1900	1900
Total Lost time (s)	4.0	4.0		4.0	4.0		4.0	4.0		4.0	4.0	
Lane Util. Factor	0.95	0.95		1.00	1.00		1.00	0.91		1.00	0.91	
Frt	1.00	0.93		1.00	0.86		1.00	1.00		1.00	0.99	
Flt Protected	0.95	0.98		0.95	1.00		0.95	1.00		0.95	1.00	
Satd. Flow (prot)	1618	1545		1703	1542		1703	4876		1703	4850	
Flt Permitted	0.50	0.56		1.00	1.00		0.95	1.00		0.95	1.00	
Satd. Flow (perm)	851	890		1792	1542		1703	4876		1703	4850	
Volume (vph)	165	5	40	65	5	65	40	2400	60	70	2665	165
Peak-hour factor, PHF	0.95	0.95	0.96	0.96	0.95	0.95	0.95	0.95	0.95	0.95	0.96	0.95
Adj. Flow (vph)	174	5	42	68	5	68	42	2526	63	74	2776	174
RTOR Reduction (vph)	0	27	0	0	66	0	0	2	0	0	6	0
Lane Group Flow (vph)	133	61	0	68	7	0	42	2587	0	74	2944	0
Turn Type	pm+pt			pm+pt			Prot			Prot		
Protected Phases	7	4		3	8		5	2		1	6	
Permitted Phases	4			8								
Actuated Green, G (s)	18.0	18.0		10.0	4.0		7.0	85.0		10.0	88.0	
Effective Green, g (s)	18.0	18.0		10.0	4.0		7.0	85.0		10.0	88.0	
Actuated g/C Ratio	0.14	0.14		0.08	0.03		0.06	0.68		0.08	0.70	
Clearance Time (s)	4.0	4.0		4.0	4.0		4.0	4.0		4.0	4.0	
Lane Grp Cap (vph)	184	181		139	49		95	3316		136	3414	
v/s Ratio Prot	c0.06	0.03		0.02	0.00		0.02	0.53		c0.04	c0.61	
v/s Ratio Perm	c0.05			0.02								
v/c Ratio	0.72	0.34		0.49	0.15		0.44	0.78		0.54	0.86	
Uniform Delay, d1	50.0	48.2		55.1	58.8		57.1	13.6		55.3	13.9	
Progression Factor	1.00	1.00		1.00	1.00		1.00	1.00		1.00	1.00	
Incremental Delay, d2	21.7	5.0		11.8	6.2		14.2	1.9		14.7	3.1	
Delay (s)	71.7	53.2		66.9	65.0		71.3	15.5		70.0	17.1	
Level of Service	E	D		E	E		E	B		E	B	
Approach Delay (s)		64.3			65.9			16.4			18.4	
Approach LOS		E			E			B			B	
Intersection Summary												
HCM Average Control Delay			20.3			HCM Level of Service				C		
HCM Volume to Capacity ratio			0.82									
Actuated Cycle Length (s)			125.0			Sum of lost time (s)			12.0			
Intersection Capacity Utilization			77.4%			ICU Level of Service			D			
Analysis Period (min)			15									

c Critical Lane Group

Lanes, Volumes, Timings
 3: Old KY 17 & KY 17 Madison Pike

8/31/2006



Lane Group	EBL	EBT	EBR	WBL	WBT	WBR	NBL	NBT	NBR	SBL	SBT	SBR
Lane Configurations												
Ideal Flow (vphpl)	1900	1900	1900	1900	1900	1900	1900	1900	1900	1900	1900	1900
Storage Length (ft)	0		0	0		0	200		0	60		0
Storage Lanes	1		0	1		0	1		0	1		0
Total Lost Time (s)	4.0	4.0	4.0	4.0	4.0	4.0	4.0	4.0	4.0	4.0	4.0	4.0
Turning Speed (mph)	15		9	15		9	15		9	15		9
Lane Util. Factor	0.95	0.95	1.00	1.00	1.00	1.00	1.00	0.91	0.91	1.00	0.91	0.91
Fr _t		0.928			0.860			0.996			0.991	
Fl _t Protected	0.950	0.977		0.950			0.950			0.950		
Satd. Flow (prot)	1618	1544	0	1703	1542	0	1703	4874	0	1703	4849	0
Fl _t Permitted	0.500	0.977					0.950			0.950		
Satd. Flow (perm)	851	1544	0	1792	1542	0	1703	4874	0	1703	4849	0
Right Turn on Red			Yes			Yes			Yes			Yes
Satd. Flow (RTOR)		31			68			6			19	
Headway Factor	1.00	1.00	1.00	1.00	1.00	1.00	1.00	1.00	1.00	1.00	1.00	1.00
Link Speed (mph)		25			25			55			55	
Link Distance (ft)		1049			589			1157			934	
Travel Time (s)		28.6			16.1			14.3			11.6	
Volume (vph)	165	5	40	65	5	65	40	2400	60	70	2665	165
Peak Hour Factor	0.95	0.95	0.96	0.96	0.95	0.95	0.95	0.95	0.95	0.95	0.96	0.95
Adj. Flow (vph)	174	5	42	68	5	68	42	2526	63	74	2776	174
Lane Group Flow (vph)	133	88	0	68	73	0	42	2589	0	74	2950	0
Turn Type	pm+pt			pm+pt			Prot			Prot		
Protected Phases	7	4		3	8		5	2		1	6	
Permitted Phases	4			8								
Minimum Split (s)	8.0	20.0		8.0	20.0		8.0	20.0		8.0	20.0	
Total Split (s)	14.0	12.0	0.0	10.0	8.0	0.0	11.0	89.0	0.0	14.0	92.0	0.0
Total Split (%)	11.2%	9.6%	0.0%	8.0%	6.4%	0.0%	8.8%	71.2%	0.0%	11.2%	73.6%	0.0%
Maximum Green (s)	10.0	8.0		6.0	4.0		7.0	85.0		10.0	88.0	
Yellow Time (s)	3.0	3.0		3.5	3.0		3.0	3.0		3.0	3.0	
All-Red Time (s)	1.0	1.0		0.5	1.0		1.0	1.0		1.0	1.0	
Lead/Lag	Lead	Lag		Lead	Lag		Lead	Lag		Lead	Lag	
Lead-Lag Optimize?	Yes	Yes		Yes	Yes		Yes	Yes		Yes	Yes	
Walk Time (s)		5.0			5.0			5.0			5.0	
Flash Dont Walk (s)		11.0			11.0			11.0			11.0	
Pedestrian Calls (#/hr)		0			0			0			0	
Act Effct Green (s)	18.0	18.0		10.0	4.0		7.0	85.0		10.0	88.0	
Actuated g/C Ratio	0.14	0.14		0.08	0.03		0.06	0.68		0.08	0.70	
v/c Ratio	0.72	0.35		0.49	0.63		0.44	0.78		0.54	0.86	
Control Delay	72.6	36.3		61.2	39.9		72.0	15.8		70.8	17.4	
Queue Delay	0.0	0.0		0.0	0.0		0.0	0.0		0.0	0.0	
Total Delay	72.6	36.3		61.2	39.9		72.0	15.8		70.8	17.4	
LOS	E	D		E	D		E	B		E	B	
Approach Delay		58.2			50.2			16.7			18.7	
Approach LOS		E			D			B			B	
Queue Length 50th (ft)	107	44		50	4		34	477		59	590	
Queue Length 95th (ft)	#208	98		96	#70		73	538		111	665	
Internal Link Dist (ft)		969			509			1077			854	
Turn Bay Length (ft)							200			60		

Lanes, Volumes, Timings
 3: Old KY 17 & KY 17 Madison Pike

8/31/2006



Lane Group	EBL	EBT	EBR	WBL	WBT	WBR	NBL	NBT	NBR	SBL	SBT	SBR
Base Capacity (vph)	184	249		139	115		95	3316		136	3419	
Starvation Cap Reductn	0	0		0	0		0	0		0	0	
Spillback Cap Reductn	0	0		0	0		0	0		0	0	
Storage Cap Reductn	0	0		0	0		0	0		0	0	
Reduced v/c Ratio	0.72	0.35		0.49	0.63		0.44	0.78		0.54	0.86	

Intersection Summary

Area Type: Other
 Cycle Length: 125
 Actuated Cycle Length: 125
 Offset: 0 (0%), Referenced to phase 2:NBT and 6:SBT, Start of Green
 Natural Cycle: 100
 Control Type: Pretimed
 Maximum v/c Ratio: 0.86
 Intersection Signal Delay: 20.0 Intersection LOS: C
 Intersection Capacity Utilization 77.4% ICU Level of Service D
 Analysis Period (min) 15
 # 95th percentile volume exceeds capacity, queue may be longer.
 Queue shown is maximum after two cycles.

Splits and Phases: 3: Old KY 17 & KY 17 Madison Pike

ø1	ø2	ø3	ø4
14 s	89 s	10 s	12 s
ø5	ø6	ø7	ø8
11 s	92 s	14 s	8 s

HCM Unsignalized Intersection Capacity Analysis
 3: Brooks/Electric & KY 17 Madison Pike

8/31/2006



Movement	WBL	WBR	NET	NER	SWL	SWT
Lane Configurations	↔		↕↔		↔	↕↕
Sign Control	Stop		Free			Free
Grade	0%		0%			0%
Volume (veh/h)	10	10	1420	80	40	710
Peak Hour Factor	0.95	0.95	0.95	0.95	0.95	0.95
Hourly flow rate (vph)	11	11	1495	84	42	747
Pedestrians						
Lane Width (ft)						
Walking Speed (ft/s)						
Percent Blockage						
Right turn flare (veh)						
Median type	TWLTL					
Median storage veh)	0					
Upstream signal (ft)						
pX, platoon unblocked						
vC, conflicting volume	1995	789			1579	
vC1, stage 1 conf vol	1537					
vC2, stage 2 conf vol	458					
vCu, unblocked vol	1995	789			1579	
tC, single (s)	7.0	7.1			4.3	
tC, 2 stage (s)	6.0					
tF (s)	3.6	3.4			2.3	
p0 queue free %	88	97			89	
cM capacity (veh/h)	91	321			386	

Direction, Lane #	WB 1	NE 1	NE 2	SW 1	SW 2	SW 3
Volume Total	21	996	582	42	374	374
Volume Left	11	0	0	42	0	0
Volume Right	11	0	84	0	0	0
cSH	141	1700	1700	386	1700	1700
Volume to Capacity	0.15	0.59	0.34	0.11	0.22	0.22
Queue Length 95th (ft)	13	0	0	9	0	0
Control Delay (s)	34.9	0.0	0.0	15.5	0.0	0.0
Lane LOS	D			C		
Approach Delay (s)	34.9	0.0		0.8		
Approach LOS	D					

Intersection Summary						
Average Delay			0.6			
Intersection Capacity Utilization			51.8%	ICU Level of Service	A	
Analysis Period (min)			15			

HCM Unsignalized Intersection Capacity Analysis
 3: Access Road & KY 17 Madison Pike

8/31/2006

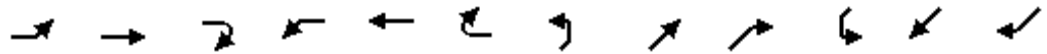

Movement	EBL	EBT	EBR	WBL	WBT	WBR	NEL	NET	NER	SWL	SWT	SWR
Lane Configurations	↶	↷			↕		↶	↷		↶	↷	
Sign Control	Stop				Stop			Free			Free	
Grade	0%				0%			0%			0%	
Volume (veh/h)	70	10	20	90	10	160	10	1960	240	150	980	50
Peak Hour Factor	0.95	0.95	0.95	0.95	0.95	0.95	0.95	0.95	0.95	0.95	0.95	0.95
Hourly flow rate (vph)	74	11	21	95	11	168	11	2063	253	158	1032	53
Pedestrians												
Lane Width (ft)												
Walking Speed (ft/s)												
Percent Blockage												
Right turn flare (veh)												
Median type	TWLTL			TWLTL								
Median storage (veh)	0			0								
Upstream signal (ft)												
pX, platoon unblocked												
vC, conflicting volume	2600	3711	542	3068	3611	1158	1084			2316		
vC1, stage 1 conf vol	1374	1374		2211	2211							
vC2, stage 2 conf vol	1226	2337		858	1400							
vCu, unblocked vol	2600	3711	542	3068	3611	1158	1084			2316		
tC, single (s)	7.7	6.7	7.1	7.7	6.7	7.1	4.3			4.3		
tC, 2 stage (s)	6.7	5.7		6.7	5.7							
tF (s)	3.6	4.1	3.4	3.6	4.1	3.4	2.3			2.3		
p0 queue free %	0	0	96	0	21	7	98			19		
cM capacity (veh/h)	0	1	469	12	13	180	605			194		

Direction, Lane #	EB 1	EB 2	WB 1	NE 1	NE 2	NE 3	SW 1	SW 2	SW 3			
Volume Total	74	32	274	11	1375	940	158	688	396			
Volume Left	74	0	95	11	0	0	158	0	0			
Volume Right	0	21	168	0	0	253	0	0	53			
cSH	0	2	27	605	1700	1700	194	1700	1700			
Volume to Capacity	776.16	14.58	9.96	0.02	0.81	0.55	0.81	0.40	0.23			
Queue Length 95th (ft)	Err	Err	Err	1	0	0	144	0	0			
Control Delay (s)	Err	Err	Err	11.1	0.0	0.0	73.8	0.0	0.0			
Lane LOS	F	F	F	B	F							
Approach Delay (s)	Err		Err	0.1	9.4							
Approach LOS	F		F									

Intersection Summary		
Average Delay	962.9	
Intersection Capacity Utilization	102.1%	ICU Level of Service G
Analysis Period (min)	15	

HCM Signalized Intersection Capacity Analysis

3: Access Road & KY 17 Madison Pike

8/31/2006

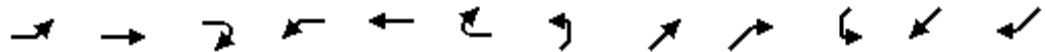

Movement	EBL	EBT	EBR	WBL	WBT	WBR	NEL	NET	NER	SWL	SWT	SWR
Lane Configurations												
Ideal Flow (vphpl)	1900	1900	1900	1900	1900	1900	1900	1900	1900	1900	1900	1900
Total Lost time (s)	4.0	4.0			4.0		4.0	4.0		4.0	4.0	
Lane Util. Factor	1.00	1.00			1.00		1.00	0.95		1.00	0.95	
Frt	1.00	0.90			0.92		1.00	0.98		1.00	0.99	
Flt Protected	0.95	1.00			0.98		0.95	1.00		0.95	1.00	
Satd. Flow (prot)	1671	1586			1586		1671	3288		1671	3318	
Flt Permitted	0.36	1.00			0.87		0.25	1.00		0.04	1.00	
Satd. Flow (perm)	632	1586			1407		442	3288		76	3318	
Volume (vph)	70	10	20	90	10	160	10	1960	240	150	980	50
Peak-hour factor, PHF	0.95	0.95	0.95	0.95	0.95	0.95	0.95	0.95	0.95	0.95	0.95	0.95
Adj. Flow (vph)	74	11	21	95	11	168	11	2063	253	158	1032	53
RTOR Reduction (vph)	0	18	0	0	46	0	0	7	0	0	3	0
Lane Group Flow (vph)	74	14	0	0	228	0	11	2309	0	158	1082	0
Turn Type	Perm		Perm			pm+pt		pm+pt				
Protected Phases	4		8			5		2		1		6
Permitted Phases	4		8			2		6				
Actuated Green, G (s)	20.0	20.0			20.0		89.0	88.2		100.2	95.4	
Effective Green, g (s)	20.0	20.0			20.0		89.0	88.2		100.2	95.4	
Actuated g/C Ratio	0.16	0.16			0.16		0.69	0.69		0.78	0.74	
Clearance Time (s)	4.0	4.0			4.0		4.0	4.0		4.0	4.0	
Vehicle Extension (s)	3.0	3.0			3.0		3.0	3.0		3.0	3.0	
Lane Grp Cap (vph)	99	247			220		315	2262		159	2469	
v/s Ratio Prot		0.01					0.00	0.70		c0.06	0.33	
v/s Ratio Perm	0.12				c0.16		0.02			c0.71		
v/c Ratio	0.75	0.06			1.04		0.03	1.02		0.99	0.44	
Uniform Delay, d1	51.7	46.1			54.1		6.1	20.0		47.5	6.2	
Progression Factor	1.00	1.00			1.00		1.00	1.00		1.00	1.00	
Incremental Delay, d2	26.1	0.1			71.0		0.0	24.3		69.2	0.1	
Delay (s)	77.8	46.2			125.1		6.1	44.3		116.7	6.4	
Level of Service	E	D			F		A	D		F	A	
Approach Delay (s)		68.2			125.1			44.1			20.4	
Approach LOS		E			F			D			C	

Intersection Summary

HCM Average Control Delay	42.9	HCM Level of Service	D
HCM Volume to Capacity ratio	0.99		
Actuated Cycle Length (s)	128.2	Sum of lost time (s)	8.0
Intersection Capacity Utilization	102.1%	ICU Level of Service	G
Analysis Period (min)	15		
c Critical Lane Group			

Lanes, Volumes, Timings
3: Access Road & KY 17 Madison Pike

8/31/2006

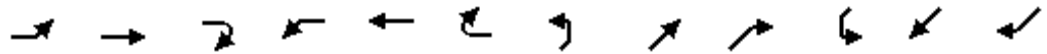

Lane Group	EBL	EBT	EBR	WBL	WBT	WBR	NEL	NET	NER	SWL	SWT	SWR
Lane Configurations												
Ideal Flow (vphpl)	1900	1900	1900	1900	1900	1900	1900	1900	1900	1900	1900	1900
Storage Length (ft)	0		0	0		0	200		0	200		0
Storage Lanes	1		0	0		0	1		0	1		0
Total Lost Time (s)	4.0	4.0	4.0	4.0	4.0	4.0	4.0	4.0	4.0	4.0	4.0	4.0
Leading Detector (ft)	50	50		50	50		50	50		50	50	
Trailing Detector (ft)	0	0		0	0		0	0		0	0	
Turning Speed (mph)	15		9	15		9	15		9	15		9
Lane Util. Factor	1.00	1.00	1.00	1.00	1.00	1.00	1.00	0.95	0.95	1.00	0.95	0.95
Fr _t		0.902			0.917			0.984			0.993	
Fl _t Protected	0.950				0.983		0.950			0.950		
Satd. Flow (prot)	1671	1587	0	0	1586	0	1671	3289	0	1671	3319	0
Fl _t Permitted	0.367				0.872		0.236			0.045		
Satd. Flow (perm)	646	1587	0	0	1407	0	415	3289	0	79	3319	0
Right Turn on Red			Yes			Yes			Yes			Yes
Satd. Flow (RTOR)		21			54			24			10	
Headway Factor	1.00	1.00	1.00	1.00	1.00	1.00	1.00	1.00	1.00	1.00	1.00	1.00
Link Speed (mph)		25			25			45			45	
Link Distance (ft)		425			596			1107			744	
Travel Time (s)		11.6			16.3			16.8			11.3	
Volume (vph)	70	10	20	90	10	160	10	1960	240	150	980	50
Peak Hour Factor	0.95	0.95	0.95	0.95	0.95	0.95	0.95	0.95	0.95	0.95	0.95	0.95
Adj. Flow (vph)	74	11	21	95	11	168	11	2063	253	158	1032	53
Lane Group Flow (vph)	74	32	0	0	274	0	11	2316	0	158	1085	0
Turn Type	Perm			Perm			pm+pt			pm+pt		
Protected Phases		4			8		5	2		1	6	
Permitted Phases	4			8			2			6		
Detector Phases	4	4		8	8		5	2		1	6	
Minimum Initial (s)	4.0	4.0		4.0	4.0		4.0	4.0		4.0	4.0	
Minimum Split (s)	20.0	20.0		21.0	21.0		8.0	20.0		8.0	20.0	
Total Split (s)	24.0	24.0	0.0	24.0	24.0	0.0	8.0	89.0	0.0	12.0	93.0	0.0
Total Split (%)	19.2%	19.2%	0.0%	19.2%	19.2%	0.0%	6.4%	71.2%	0.0%	9.6%	74.4%	0.0%
Maximum Green (s)	20.0	20.0		20.0	20.0		4.0	85.0		8.0	89.0	
Yellow Time (s)	3.5	3.5		3.5	3.5		3.5	3.5		3.5	3.5	
All-Red Time (s)	0.5	0.5		0.5	0.5		0.5	0.5		0.5	0.5	
Lead/Lag							Lead	Lag		Lead	Lag	
Lead-Lag Optimize?							Yes	Yes		Yes	Yes	
Vehicle Extension (s)	3.0	3.0		3.0	3.0		3.0	3.0		3.0	3.0	
Recall Mode	None	None		None	None		None	Min		None	Min	
Walk Time (s)	5.0	5.0		5.0	5.0			5.0			5.0	
Flash Dont Walk (s)	11.0	11.0		11.0	11.0			11.0			11.0	
Pedestrian Calls (#/hr)	0	0		0	0			0			0	
Act Effct Green (s)	20.0	20.0			20.0		89.1	85.0		97.0	95.4	
Actuated g/C Ratio	0.16	0.16			0.16		0.68	0.68		0.78	0.76	
v/c Ratio	0.72	0.12			1.01		0.03	1.03		0.97	0.43	
Control Delay	86.4	24.7			100.5		4.5	48.4		94.6	6.0	
Queue Delay	0.0	0.0			0.0		0.0	0.0		0.0	0.0	
Total Delay	86.4	24.7			100.5		4.5	48.4		94.6	6.0	
LOS	F	C			F		A	D		F	A	

Lanes, Volumes, Timings
 3: Access Road & KY 17 Madison Pike

8/31/2006

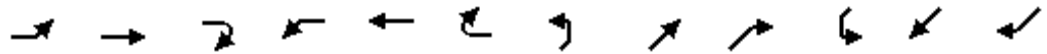

Lane Group	EBL	EBT	EBR	WBL	WBT	WBR	NEL	NET	NER	SWL	SWT	SWR
Approach Delay		67.8			100.5			48.2			17.3	
Approach LOS		E			F			D			B	
Queue Length 50th (ft)	57	8			~189		2	~1054		81	127	
Queue Length 95th (ft)	#140	38			#372		6	#1190		#223	214	
Internal Link Dist (ft)		345			516			1027			664	
Turn Bay Length (ft)							200			200		
Base Capacity (vph)	103	272			270		319	2244		163	2536	
Starvation Cap Reductn	0	0			0		0	0		0	0	
Spillback Cap Reductn	0	0			0		0	0		0	0	
Storage Cap Reductn	0	0			0		0	0		0	0	
Reduced v/c Ratio	0.72	0.12			1.01		0.03	1.03		0.97	0.43	

Intersection Summary

Area Type:	Other
Cycle Length:	125
Actuated Cycle Length:	125
Natural Cycle:	140
Control Type:	Actuated-Uncoordinated
Maximum v/c Ratio:	1.03
Intersection Signal Delay:	42.6
Intersection LOS:	D
Intersection Capacity Utilization:	102.1%
ICU Level of Service:	G
Analysis Period (min):	15
~ Volume exceeds capacity, queue is theoretically infinite. Queue shown is maximum after two cycles.	
# 95th percentile volume exceeds capacity, queue may be longer. Queue shown is maximum after two cycles.	

Splits and Phases: 3: Access Road & KY 17 Madison Pike

ø1	ø2	ø4
12 s	89 s	24 s
ø5	ø6	ø8
8 s	93 s	24 s

HCM Signalized Intersection Capacity Analysis

3: Access Road & KY 17 Madison Pike

8/31/2006

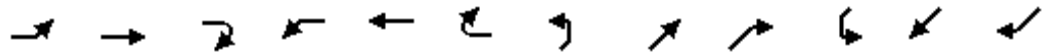

Movement	EBL	EBT	EBR	WBL	WBT	WBR	NEL	NET	NER	SWL	SWT	SWR
Lane Configurations	↔	↔		↔	↔		↔	↕↕	↔	↔	↕↕	
Ideal Flow (vphpl)	1900	1900	1900	1900	1900	1900	1900	1900	1900	1900	1900	1900
Total Lost time (s)	4.0	4.0		4.0	4.0		4.0	4.0	4.0	4.0	4.0	
Lane Util. Factor	1.00	1.00		1.00	1.00		1.00	0.95	1.00	1.00	0.95	
Frt	1.00	0.90		1.00	0.86		1.00	1.00	0.85	1.00	0.99	
Flt Protected	0.95	1.00		0.95	1.00		0.95	1.00	1.00	0.95	1.00	
Satd. Flow (prot)	1671	1586		1671	1512		1671	3343	1495	1671	3318	
Flt Permitted	0.32	1.00		0.74	1.00		0.23	1.00	1.00	0.05	1.00	
Satd. Flow (perm)	564	1586		1295	1512		408	3343	1495	84	3318	
Volume (vph)	70	10	20	90	10	160	10	1960	240	150	980	50
Peak-hour factor, PHF	0.95	0.95	0.95	0.95	0.95	0.95	0.95	0.95	0.95	0.95	0.95	0.95
Adj. Flow (vph)	74	11	21	95	11	168	11	2063	253	158	1032	53
RTOR Reduction (vph)	0	18	0	0	76	0	0	0	60	0	3	0
Lane Group Flow (vph)	74	14	0	95	103	0	11	2063	193	158	1082	0
Turn Type	pm+pt		pm+pt		pm+pt		Perm		pm+pt			
Protected Phases	7	4		3	8		5	2		1	6	
Permitted Phases	4			8			2		2	6		
Actuated Green, G (s)	20.0	16.0		20.0	16.0		84.0	80.0	80.0	93.0	85.0	
Effective Green, g (s)	20.0	16.0		20.0	16.0		84.0	80.0	80.0	93.0	85.0	
Actuated g/C Ratio	0.16	0.13		0.16	0.13		0.67	0.64	0.64	0.74	0.68	
Clearance Time (s)	4.0	4.0		4.0	4.0		4.0	4.0	4.0	4.0	4.0	
Lane Grp Cap (vph)	126	203		219	194		315	2140	957	177	2256	
v/s Ratio Prot	c0.02	0.01		0.01	0.07		0.00	c0.62		c0.06	0.33	
v/s Ratio Perm	c0.08			0.06			0.02		0.13	0.60		
v/c Ratio	0.59	0.07		0.43	0.53		0.03	0.96	0.20	0.89	0.48	
Uniform Delay, d1	47.7	47.9		46.9	51.0		7.1	21.1	9.3	41.8	9.5	
Progression Factor	1.00	1.00		1.00	1.00		1.00	1.00	1.00	1.00	1.00	
Incremental Delay, d2	18.5	0.6		6.1	10.1		0.2	12.7	0.5	44.2	0.7	
Delay (s)	66.2	48.6		53.0	61.0		7.4	33.8	9.8	86.0	10.2	
Level of Service	E	D		D	E		A	C	A	F	B	
Approach Delay (s)		60.9			58.3			31.1			19.9	
Approach LOS		E			E			C			B	

Intersection Summary

HCM Average Control Delay	30.2	HCM Level of Service	C
HCM Volume to Capacity ratio	0.89		
Actuated Cycle Length (s)	125.0	Sum of lost time (s)	16.0
Intersection Capacity Utilization	90.1%	ICU Level of Service	E
Analysis Period (min)	15		

c Critical Lane Group

Lanes, Volumes, Timings
 3: Access Road & KY 17 Madison Pike

8/31/2006

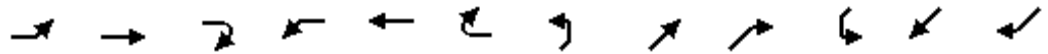

Lane Group	EBL	EBT	EBR	WBL	WBT	WBR	NEL	NET	NER	SWL	SWT	SWR
Lane Configurations												
Ideal Flow (vphpl)	1900	1900	1900	1900	1900	1900	1900	1900	1900	1900	1900	1900
Storage Length (ft)	0		0	0		0	300		200	300		200
Storage Lanes	1		0	1		0	1		1	2		0
Total Lost Time (s)	4.0	4.0	4.0	4.0	4.0	4.0	4.0	4.0	4.0	4.0	4.0	4.0
Turning Speed (mph)	15		9	15		9	15		9	15		9
Lane Util. Factor	1.00	1.00	1.00	1.00	1.00	1.00	1.00	0.95	1.00	1.00	0.95	0.95
Fr _t		0.902			0.859				0.850		0.993	
Fl _t Protected	0.950			0.950			0.950			0.950		
Satd. Flow (prot)	1671	1587	0	1671	1511	0	1671	3343	1495	1671	3319	0
Fl _t Permitted	0.321			0.736			0.232			0.048		
Satd. Flow (perm)	565	1587	0	1295	1511	0	408	3343	1495	84	3319	0
Right Turn on Red			Yes			Yes			Yes			Yes
Satd. Flow (RTOR)		21			87				168		9	
Headway Factor	1.00	1.00	1.00	1.00	1.00	1.00	1.00	1.00	1.00	1.00	1.00	1.00
Link Speed (mph)		25			25			45			45	
Link Distance (ft)		425			596			1107			744	
Travel Time (s)		11.6			16.3			16.8			11.3	
Volume (vph)	70	10	20	90	10	160	10	1960	240	150	980	50
Peak Hour Factor	0.95	0.95	0.95	0.95	0.95	0.95	0.95	0.95	0.95	0.95	0.95	0.95
Adj. Flow (vph)	74	11	21	95	11	168	11	2063	253	158	1032	53
Lane Group Flow (vph)	74	32	0	95	179	0	11	2063	253	158	1085	0
Turn Type	pm+pt			pm+pt			pm+pt		Perm	pm+pt		
Protected Phases	7	4		3	8		5	2		1	6	
Permitted Phases	4			8			2		2	6		
Minimum Split (s)	8.0	20.0		8.0	20.0		8.0	20.0	20.0	10.0	20.0	
Total Split (s)	8.0	20.0	0.0	8.0	20.0	0.0	8.0	84.0	84.0	13.0	89.0	0.0
Total Split (%)	6.4%	16.0%	0.0%	6.4%	16.0%	0.0%	6.4%	67.2%	67.2%	10.4%	71.2%	0.0%
Maximum Green (s)	4.0	16.0		4.0	16.0		4.0	80.0	80.0	9.0	85.0	
Yellow Time (s)	3.0	3.0		3.0	3.0		3.0	3.0	3.0	3.0	3.0	
All-Red Time (s)	1.0	1.0		1.0	1.0		1.0	1.0	1.0	1.0	1.0	
Lead/Lag	Lead	Lag		Lead	Lag		Lead	Lag	Lag	Lead	Lag	
Lead-Lag Optimize?	Yes	Yes		Yes	Yes		Yes	Yes	Yes	Yes	Yes	
Walk Time (s)		5.0			5.0			5.0	5.0		5.0	
Flash Dont Walk (s)		11.0			11.0			11.0	11.0		11.0	
Pedestrian Calls (#/hr)		0			0			0	0		0	
Act Effct Green (s)	20.0	16.0		20.0	16.0		84.0	80.0	80.0	93.0	85.0	
Actuated g/C Ratio	0.16	0.13		0.16	0.13		0.67	0.64	0.64	0.74	0.68	
v/c Ratio	0.59	0.14		0.43	0.67		0.03	0.96	0.25	0.89	0.48	
Control Delay	64.3	27.0		51.9	39.3		4.7	34.4	3.8	74.8	10.3	
Queue Delay	0.0	0.0		0.0	0.0		0.0	0.0	0.0	0.0	0.0	
Total Delay	64.3	27.0		51.9	39.3		4.7	34.4	3.8	74.8	10.3	
LOS	E	C		D	D		A	C	A	E	B	
Approach Delay		53.0			43.7			30.9			18.5	
Approach LOS		D			D			C			B	
Queue Length 50th (ft)	51	8		66	71		2	768	24	79	198	
Queue Length 95th (ft)	#105	39		119	152		7	#1015	58	#211	243	
Internal Link Dist (ft)		345			516			1027			664	
Turn Bay Length (ft)							300		200	300		

Lanes, Volumes, Timings
 3: Access Road & KY 17 Madison Pike

9/19/2006

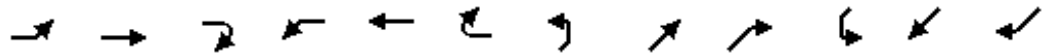

Lane Group	EBL	EBT	EBR	WBL	WBT	WBR	NEL	NET	NER	SWL	SWT	SWR
Base Capacity (vph)	126	221		219	269		315	2140	1017	177	2260	
Starvation Cap Reductn	0	0		0	0		0	0	0	0	0	
Spillback Cap Reductn	0	0		0	0		0	0	0	0	0	
Storage Cap Reductn	0	0		0	0		0	0	0	0	0	
Reduced v/c Ratio	0.59	0.14		0.43	0.67		0.03	0.96	0.25	0.89	0.48	

Intersection Summary

Area Type: Other
 Cycle Length: 125
 Actuated Cycle Length: 125
 Offset: 0 (0%), Referenced to phase 2:NETL and 6:SWTL, Start of Green
 Natural Cycle: 110
 Control Type: Pretimed
 Maximum v/c Ratio: 0.96
 Intersection Signal Delay: 28.5 Intersection LOS: C
 Intersection Capacity Utilization 90.1% ICU Level of Service E
 Analysis Period (min) 15
 # 95th percentile volume exceeds capacity, queue may be longer.
 Queue shown is maximum after two cycles.

Splits and Phases: 3: Access Road & KY 17 Madison Pike

ø1	ø2	ø3	ø4
13 s	84 s	8 s	20 s
ø5	ø6	ø7	ø8
8 s	89 s	8 s	20 s

HCM Unsignalized Intersection Capacity Analysis
 3: Brooks/Electric & KY 17 Madison Pike

8/31/2006



Movement	WBL	WBR	NET	NER	SWL	SWT
Lane Configurations	↔		↕↔		↔	↕↕
Sign Control	Stop		Free			Free
Grade	0%		0%			0%
Volume (veh/h)	50	30	1000	70	20	1180
Peak Hour Factor	0.95	0.95	0.95	0.95	0.95	0.95
Hourly flow rate (vph)	53	32	1053	74	21	1242
Pedestrians						
Lane Width (ft)						
Walking Speed (ft/s)						
Percent Blockage						
Right turn flare (veh)						
Median type	TWLTL					
Median storage veh	0					
Upstream signal (ft)						
pX, platoon unblocked						
vC, conflicting volume	1753	563			1126	
vC1, stage 1 conf vol	1089					
vC2, stage 2 conf vol	663					
vCu, unblocked vol	1753	563			1126	
tC, single (s)	7.0	7.1			4.3	
tC, 2 stage (s)	6.0					
tF (s)	3.6	3.4			2.3	
p0 queue free %	61	93			96	
cM capacity (veh/h)	136	454			582	
Direction, Lane #	WB 1	NE 1	NE 2	SW 1	SW 2	SW 3
Volume Total	84	702	425	21	621	621
Volume Left	53	0	0	21	0	0
Volume Right	32	0	74	0	0	0
cSH	185	1700	1700	582	1700	1700
Volume to Capacity	0.46	0.41	0.25	0.04	0.37	0.37
Queue Length 95th (ft)	54	0	0	3	0	0
Control Delay (s)	39.9	0.0	0.0	11.4	0.0	0.0
Lane LOS	E			B		
Approach Delay (s)	39.9	0.0		0.2		
Approach LOS	E					
Intersection Summary						
Average Delay			1.5			
Intersection Capacity Utilization			43.9%	ICU Level of Service	A	
Analysis Period (min)			15			

HCM Unsignalized Intersection Capacity Analysis
 3: Access Road & KY 17 Madison Pike

8/31/2006

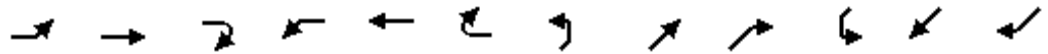

Movement	EBL	EBT	EBR	WBL	WBT	WBR	NEL	NET	NER	SWL	SWT	SWR
Lane Configurations	↔	↔			↔		↔	↔		↔	↔	
Sign Control	Stop				Stop			Free			Free	
Grade	0%				0%			0%			0%	
Volume (veh/h)	80	20	20	250	20	200	20	1380	320	170	1610	100
Peak Hour Factor	0.95	0.95	0.95	0.95	0.95	0.95	0.95	0.95	0.95	0.95	0.95	0.95
Hourly flow rate (vph)	84	21	21	263	21	211	21	1453	337	179	1695	105
Pedestrians												
Lane Width (ft)												
Walking Speed (ft/s)												
Percent Blockage												
Right turn flare (veh)												
Median type	TWLTL			TWLTL								
Median storage veh	0			0								
Upstream signal (ft)												
pX, platoon unblocked												
vC, conflicting volume	3095	3937	900	2900	3821	895	1800			1789		
vC1, stage 1 conf vol	2105	2105		1663	1663							
vC2, stage 2 conf vol	989	1832		1237	2158							
vCu, unblocked vol	3095	3937	900	2900	3821	895	1800			1789		
tC, single (s)	7.7	6.7	7.1	7.7	6.7	7.1	4.3			4.3		
tC, 2 stage (s)	6.7	5.7		6.7	5.7							
tF (s)	3.6	4.1	3.4	3.6	4.1	3.4	2.3			2.3		
p0 queue free %	0	0	92	0	0	23	93			44		
cM capacity (veh/h)	0	1	270	6	9	272	314			318		

Direction, Lane #	EB 1	EB 2	WB 1	NE 1	NE 2	NE 3	SW 1	SW 2	SW 3		
Volume Total	84	42	495	21	968	821	179	1130	670		
Volume Left	84	0	263	21	0	0	179	0	0		
Volume Right	0	21	211	0	0	337	0	0	105		
cSH	0	2	10	314	1700	1700	318	1700	1700		
Volume to Capacity	Err	18.97	47.67	0.07	0.57	0.48	0.56	0.66	0.39		
Queue Length 95th (ft)	Err	Err	Err	5	0	0	81	0	0		
Control Delay (s)	Err	Err	Err	17.3	0.0	0.0	30.0	0.0	0.0		
Lane LOS	F	F	F	C	D						
Approach Delay (s)	Err		Err	0.2			2.7				
Approach LOS	F		F								

Intersection Summary									
Average Delay	Err								
Intersection Capacity Utilization	101.6%			ICU Level of Service			G		
Analysis Period (min)	15								

HCM Signalized Intersection Capacity Analysis

3: Access Road & KY 17 Madison Pike

8/31/2006

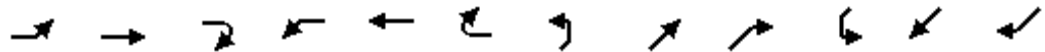

Movement	EBL	EBT	EBR	WBL	WBT	WBR	NEL	NET	NER	SWL	SWT	SWR
Lane Configurations	↔	↔			↔		↔	↔		↔	↔	
Ideal Flow (vphpl)	1900	1900	1900	1900	1900	1900	1900	1900	1900	1900	1900	1900
Total Lost time (s)	4.0	4.0			4.0		4.0	4.0		4.0	4.0	
Lane Util. Factor	1.00	1.00			1.00		1.00	0.95		1.00	0.95	
Frt	1.00	0.92			0.94		1.00	0.97		1.00	0.99	
Flt Protected	0.95	1.00			0.97		0.95	1.00		0.95	1.00	
Satd. Flow (prot)	1671	1627			1615		1671	3248		1671	3313	
Flt Permitted	0.51	1.00			0.81		0.06	1.00		0.06	1.00	
Satd. Flow (perm)	901	1627			1345		109	3248		103	3313	
Volume (vph)	80	20	20	250	20	200	20	1380	320	170	1610	100
Peak-hour factor, PHF	0.95	0.95	0.95	0.95	0.95	0.95	0.95	0.95	0.95	0.95	0.95	0.95
Adj. Flow (vph)	84	21	21	263	21	211	21	1453	337	179	1695	105
RTOR Reduction (vph)	0	14	0	0	22	0	0	16	0	0	4	0
Lane Group Flow (vph)	84	28	0	0	473	0	21	1774	0	179	1796	0
Turn Type	Perm		Perm			pm+pt		pm+pt				
Protected Phases	4		8			5		2		1		6
Permitted Phases	4		8			2		6				
Actuated Green, G (s)	41.0	41.0			41.0		67.0	64.6		77.6	71.2	
Effective Green, g (s)	41.0	41.0			41.0		67.0	64.6		77.6	71.2	
Actuated g/C Ratio	0.32	0.32			0.32		0.53	0.51		0.61	0.56	
Clearance Time (s)	4.0	4.0			4.0		4.0	4.0		4.0	4.0	
Vehicle Extension (s)	3.0	3.0			3.0		3.0	3.0		3.0	3.0	
Lane Grp Cap (vph)	292	527			436		87	1657		175	1863	
v/s Ratio Prot	0.02					0.00		c0.55		c0.07		0.54
v/s Ratio Perm	0.09		c0.35			0.12		0.56				
v/c Ratio	0.29	0.05			1.09		0.24	1.07		1.02	0.96	
Uniform Delay, d1	31.9	29.4			42.8		24.9	31.0		41.7	26.5	
Progression Factor	1.00	1.00			1.00		1.00	1.00		1.00	1.00	
Incremental Delay, d2	0.5	0.0			68.2		1.4	43.8		74.1	13.3	
Delay (s)	32.5	29.5			111.0		26.3	74.8		115.9	39.8	
Level of Service	C	C			F		C	E		F	D	
Approach Delay (s)	31.5		111.0			74.2		46.7				
Approach LOS	C		F			E		D				

Intersection Summary

HCM Average Control Delay	64.8	HCM Level of Service	E
HCM Volume to Capacity ratio	1.07		
Actuated Cycle Length (s)	126.6	Sum of lost time (s)	12.0
Intersection Capacity Utilization	101.6%	ICU Level of Service	G
Analysis Period (min)	15		
c Critical Lane Group			

Lanes, Volumes, Timings
 3: Access Road & KY 17 Madison Pike

8/31/2006

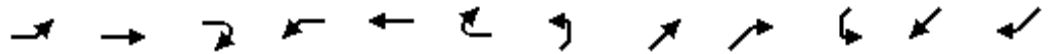

Lane Group	EBL	EBT	EBR	WBL	WBT	WBR	NEL	NET	NER	SWL	SWT	SWR
Lane Configurations												
Ideal Flow (vphpl)	1900	1900	1900	1900	1900	1900	1900	1900	1900	1900	1900	1900
Storage Length (ft)	0		0	0		0	200		0	200		0
Storage Lanes	1		0	0		0	1		0	1		0
Total Lost Time (s)	4.0	4.0	4.0	4.0	4.0	4.0	4.0	4.0	4.0	4.0	4.0	4.0
Leading Detector (ft)	50	50		50	50		50	50		50	50	
Trailing Detector (ft)	0	0		0	0		0	0		0	0	
Turning Speed (mph)	15		9	15		9	15		9	15		9
Lane Util. Factor	1.00	1.00	1.00	1.00	1.00	1.00	1.00	0.95	0.95	1.00	0.95	0.95
Fr _t		0.925			0.942			0.972			0.991	
Fl _t Protected	0.950				0.974		0.950			0.950		
Satd. Flow (prot)	1671	1627	0	0	1614	0	1671	3249	0	1671	3313	0
Fl _t Permitted	0.511				0.811		0.063			0.060		
Satd. Flow (perm)	899	1627	0	0	1344	0	111	3249	0	106	3313	0
Right Turn on Red			Yes			Yes			Yes			Yes
Satd. Flow (RTOR)		21			32			32			8	
Headway Factor	1.00	1.00	1.00	1.00	1.00	1.00	1.00	1.00	1.00	1.00	1.00	1.00
Link Speed (mph)		25			25			45			45	
Link Distance (ft)		425			596			1107			744	
Travel Time (s)		11.6			16.3			16.8			11.3	
Volume (vph)	80	20	20	250	20	200	20	1380	320	170	1610	100
Peak Hour Factor	0.95	0.95	0.95	0.95	0.95	0.95	0.95	0.95	0.95	0.95	0.95	0.95
Adj. Flow (vph)	84	21	21	263	21	211	21	1453	337	179	1695	105
Lane Group Flow (vph)	84	42	0	0	495	0	21	1790	0	179	1800	0
Turn Type	Perm			Perm			pm+pt			pm+pt		
Protected Phases		4			8		5	2		1	6	
Permitted Phases	4			8			2			6		
Detector Phases	4	4		8	8		5	2		1	6	
Minimum Initial (s)	4.0	4.0		4.0	4.0		4.0	4.0		4.0	4.0	
Minimum Split (s)	20.0	20.0		21.0	21.0		8.0	20.0		8.0	20.0	
Total Split (s)	45.0	45.0	0.0	45.0	45.0	0.0	8.0	67.0	0.0	13.0	72.0	0.0
Total Split (%)	36.0%	36.0%	0.0%	36.0%	36.0%	0.0%	6.4%	53.6%	0.0%	10.4%	57.6%	0.0%
Maximum Green (s)	41.0	41.0		41.0	41.0		4.0	63.0		9.0	68.0	
Yellow Time (s)	3.5	3.5		3.5	3.5		3.5	3.5		3.5	3.5	
All-Red Time (s)	0.5	0.5		0.5	0.5		0.5	0.5		0.5	0.5	
Lead/Lag							Lead	Lag		Lead	Lag	
Lead-Lag Optimize?							Yes	Yes		Yes	Yes	
Vehicle Extension (s)	3.0	3.0		3.0	3.0		3.0	3.0		3.0	3.0	
Recall Mode	None	None		None	None		None	Min		None	Min	
Walk Time (s)	5.0	5.0		5.0	5.0			5.0			5.0	
Flash Dont Walk (s)	11.0	11.0		11.0	11.0			11.0			11.0	
Pedestrian Calls (#/hr)	0	0		0	0			0			0	
Act Effct Green (s)	41.0	41.0			41.0		67.1	63.0		76.0	71.2	
Actuated g/C Ratio	0.33	0.33			0.33		0.52	0.50		0.61	0.57	
v/c Ratio	0.28	0.08			1.07		0.20	1.08		1.01	0.95	
Control Delay	34.5	17.9			100.3		14.6	78.5		101.7	38.4	
Queue Delay	0.0	0.0			0.0		0.0	0.0		0.0	0.0	
Total Delay	34.5	17.9			100.3		14.6	78.5		101.7	38.4	
LOS	C	B			F		B	E		F	D	

Lanes, Volumes, Timings
 3: Access Road & KY 17 Madison Pike

8/31/2006

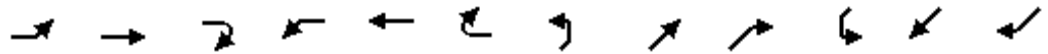

Lane Group	EBL	EBT	EBR	WBL	WBT	WBR	NEL	NET	NER	SWL	SWT	SWR
Approach Delay		29.0			100.3			77.7			44.1	
Approach LOS		C			F			E			D	
Queue Length 50th (ft)	50	12			~426		6	~847		~100	731	
Queue Length 95th (ft)	97	38			#643		17	#988		#253	#934	
Internal Link Dist (ft)		345			516			1027			664	
Turn Bay Length (ft)							200			200		
Base Capacity (vph)	295	548			462		107	1653		177	1890	
Starvation Cap Reductn	0	0			0		0	0		0	0	
Spillback Cap Reductn	0	0			0		0	0		0	0	
Storage Cap Reductn	0	0			0		0	0		0	0	
Reduced v/c Ratio	0.28	0.08			1.07		0.20	1.08		1.01	0.95	

Intersection Summary

Area Type:	Other
Cycle Length:	125
Actuated Cycle Length:	125
Natural Cycle:	120
Control Type:	Actuated-Uncoordinated
Maximum v/c Ratio:	1.08
Intersection Signal Delay:	63.8
Intersection LOS:	E
Intersection Capacity Utilization:	101.6%
ICU Level of Service:	G
Analysis Period (min):	15
~ Volume exceeds capacity, queue is theoretically infinite. Queue shown is maximum after two cycles.	
# 95th percentile volume exceeds capacity, queue may be longer. Queue shown is maximum after two cycles.	

Splits and Phases: 3: Access Road & KY 17 Madison Pike

ø1	ø2	ø4
13 s	67 s	45 s
ø5	ø6	ø8
8 s	72 s	45 s

HCM Signalized Intersection Capacity Analysis

3: Access Road & KY 17 Madison Pike

8/31/2006

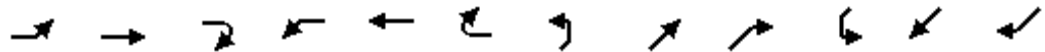

Movement	EBL	EBT	EBR	WBL	WBT	WBR	NEL	NET	NER	SWL	SWT	SWR
Lane Configurations												
Ideal Flow (vphpl)	1900	1900	1900	1900	1900	1900	1900	1900	1900	1900	1900	1900
Total Lost time (s)	4.0	4.0		4.0	4.0		4.0	4.0	4.0	4.0	4.0	
Lane Util. Factor	1.00	1.00		1.00	1.00		1.00	0.95	1.00	1.00	0.95	
Frt	1.00	0.92		1.00	0.86		1.00	1.00	0.85	1.00	0.99	
Flt Protected	0.95	1.00		0.95	1.00		0.95	1.00	1.00	0.95	1.00	
Satd. Flow (prot)	1671	1627		1671	1519		1671	3343	1495	1671	3313	
Flt Permitted	0.50	1.00		0.58	1.00		0.06	1.00	1.00	0.06	1.00	
Satd. Flow (perm)	881	1627		1027	1519		110	3343	1495	108	3313	
Volume (vph)	80	20	20	250	20	200	20	1380	320	170	1610	100
Peak-hour factor, PHF	0.95	0.95	0.95	0.95	0.95	0.95	0.95	0.95	0.95	0.95	0.95	0.95
Adj. Flow (vph)	84	21	21	263	21	211	21	1453	337	179	1695	105
RTOR Reduction (vph)	0	18	0	0	155	0	0	0	114	0	4	0
Lane Group Flow (vph)	84	24	0	263	77	0	21	1453	223	179	1796	0
Turn Type	pm+pt			pm+pt			pm+pt			Perm	pm+pt	
Protected Phases	7	4		3	8		5	2			1	6
Permitted Phases	4			8			2		2		6	
Actuated Green, G (s)	23.0	16.0		35.0	24.0		67.0	64.0	64.0	82.0	75.0	
Effective Green, g (s)	23.0	16.0		35.0	24.0		67.0	64.0	64.0	82.0	75.0	
Actuated g/C Ratio	0.18	0.13		0.28	0.19		0.54	0.51	0.51	0.66	0.60	
Clearance Time (s)	4.0	4.0		4.0	4.0		4.0	4.0	4.0	4.0	4.0	
Lane Grp Cap (vph)	206	208		365	292		96	1712	765	246	1988	
v/s Ratio Prot	0.02	0.01		c0.09	0.05		0.01	0.43		c0.08	c0.54	
v/s Ratio Perm	0.05			c0.12			0.11		0.15	0.40		
v/c Ratio	0.41	0.11		0.72	0.26		0.22	0.85	0.29	0.73	0.90	
Uniform Delay, d1	43.9	48.2		38.9	43.0		20.7	26.3	17.5	33.8	21.8	
Progression Factor	1.00	1.00		1.00	1.00		1.00	1.00	1.00	1.00	1.00	
Incremental Delay, d2	5.9	1.1		11.6	2.2		5.2	5.5	1.0	17.1	7.3	
Delay (s)	49.7	49.3		50.6	45.2		25.9	31.8	18.5	50.9	29.1	
Level of Service	D	D		D	D		C	C	B	D	C	
Approach Delay (s)		49.6			48.0			29.2			31.1	
Approach LOS		D			D			C			C	

Intersection Summary

HCM Average Control Delay	32.8	HCM Level of Service	C
HCM Volume to Capacity ratio	0.85		
Actuated Cycle Length (s)	125.0	Sum of lost time (s)	12.0
Intersection Capacity Utilization	82.2%	ICU Level of Service	E
Analysis Period (min)	15		

c Critical Lane Group

Lanes, Volumes, Timings
 3: Access Road & KY 17 Madison Pike

8/31/2006

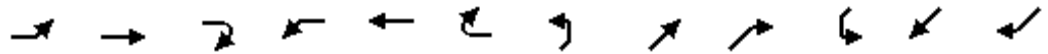

Lane Group	EBL	EBT	EBR	WBL	WBT	WBR	NEL	NET	NER	SWL	SWT	SWR
Lane Configurations												
Ideal Flow (vphpl)	1900	1900	1900	1900	1900	1900	1900	1900	1900	1900	1900	1900
Storage Length (ft)	0		0	0		0	300		200	300		60
Storage Lanes	1		0	1		0	1		1	2		0
Total Lost Time (s)	4.0	4.0	4.0	4.0	4.0	4.0	4.0	4.0	4.0	4.0	4.0	4.0
Turning Speed (mph)	15		9	15		9	15		9	15		9
Lane Util. Factor	1.00	1.00	1.00	1.00	1.00	1.00	1.00	0.95	1.00	1.00	0.95	0.95
Fr _t		0.925			0.864				0.850		0.991	
Fl _t Protected	0.950			0.950			0.950			0.950		
Satd. Flow (prot)	1671	1627	0	1671	1520	0	1671	3343	1495	1671	3313	0
Fl _t Permitted	0.501			0.584			0.062			0.061		
Satd. Flow (perm)	881	1627	0	1027	1520	0	109	3343	1495	107	3313	0
Right Turn on Red			Yes			Yes			Yes			Yes
Satd. Flow (RTOR)		21			192				234		9	
Headway Factor	1.00	1.00	1.00	1.00	1.00	1.00	1.00	1.00	1.00	1.00	1.00	1.00
Link Speed (mph)		25			25			45			45	
Link Distance (ft)		425			596			1107			744	
Travel Time (s)		11.6			16.3			16.8			11.3	
Volume (vph)	80	20	20	250	20	200	20	1380	320	170	1610	100
Peak Hour Factor	0.95	0.95	0.95	0.95	0.95	0.95	0.95	0.95	0.95	0.95	0.95	0.95
Adj. Flow (vph)	84	21	21	263	21	211	21	1453	337	179	1695	105
Lane Group Flow (vph)	84	42	0	263	232	0	21	1453	337	179	1800	0
Turn Type	pm+pt			pm+pt			pm+pt		Perm	pm+pt		
Protected Phases	7	4		3	8		5	2		1	6	
Permitted Phases	4			8			2		2	6		
Minimum Split (s)	8.0	20.0		8.0	20.0		7.0	20.0	20.0	10.0	20.0	
Total Split (s)	11.0	20.0	0.0	19.0	28.0	0.0	7.0	68.0	68.0	18.0	79.0	0.0
Total Split (%)	8.8%	16.0%	0.0%	15.2%	22.4%	0.0%	5.6%	54.4%	54.4%	14.4%	63.2%	0.0%
Maximum Green (s)	7.0	16.0		15.0	24.0		3.0	64.0	64.0	14.0	75.0	
Yellow Time (s)	3.5	3.0		3.5	3.0		3.0	3.0	3.0	3.0	3.0	
All-Red Time (s)	0.5	1.0		0.5	1.0		1.0	1.0	1.0	1.0	1.0	
Lead/Lag	Lead	Lag		Lead	Lag		Lead	Lag	Lag	Lead	Lag	
Lead-Lag Optimize?	Yes	Yes		Yes	Yes		Yes	Yes	Yes	Yes	Yes	
Walk Time (s)		5.0			5.0			5.0	5.0		5.0	
Flash Dont Walk (s)		11.0			11.0			11.0	11.0		11.0	
Pedestrian Calls (#/hr)		0			0			0	0		0	
Act Effct Green (s)	23.0	16.0		35.0	24.0		67.0	64.0	64.0	82.0	75.0	
Actuated g/C Ratio	0.18	0.13		0.28	0.19		0.54	0.51	0.51	0.66	0.60	
v/c Ratio	0.41	0.19		0.72	0.52		0.22	0.85	0.38	0.73	0.90	
Control Delay	41.9	31.5		51.4	14.5		14.2	32.3	6.8	45.7	29.6	
Queue Delay	0.0	0.0		0.0	0.0		0.0	0.0	0.0	0.0	0.0	
Total Delay	41.9	31.5		51.4	14.5		14.2	32.3	6.8	45.7	29.6	
LOS	D	C		D	B		B	C	A	D	C	
Approach Delay		38.4			34.1			27.4			31.1	
Approach LOS		D			C			C			C	
Queue Length 50th (ft)	52	15		182	27		6	516	42	90	630	
Queue Length 95th (ft)	95	51		#273	105		15	625	104	#193	766	
Internal Link Dist (ft)		345			516			1027			664	
Turn Bay Length (ft)							300		200	300		

KY 17 @ TANK pm Build Option 1
 DLZ, LLC

Lanes, Volumes, Timings
 3: Access Road & KY 17 Madison Pike

8/31/2006



Lane Group	EBL	EBT	EBR	WBL	WBT	WBR	NEL	NET	NER	SWL	SWT	SWR
Base Capacity (vph)	206	227		365	447		96	1712	880	245	1991	
Starvation Cap Reductn	0	0		0	0		0	0	0	0	0	
Spillback Cap Reductn	0	0		0	0		0	0	0	0	0	
Storage Cap Reductn	0	0		0	0		0	0	0	0	0	
Reduced v/c Ratio	0.41	0.19		0.72	0.52		0.22	0.85	0.38	0.73	0.90	

Intersection Summary

Area Type: Other
 Cycle Length: 125
 Actuated Cycle Length: 125
 Offset: 0 (0%), Referenced to phase 2:NETL and 6:SWTL, Start of Green
 Natural Cycle: 90
 Control Type: Pretimed
 Maximum v/c Ratio: 0.90
 Intersection Signal Delay: 30.1 Intersection LOS: C
 Intersection Capacity Utilization 82.2% ICU Level of Service E
 Analysis Period (min) 15
 # 95th percentile volume exceeds capacity, queue may be longer.
 Queue shown is maximum after two cycles.

Splits and Phases: 3: Access Road & KY 17 Madison Pike

ø1	ø2	ø3	ø4
18 s	68 s	19 s	20 s
ø5	ø6	ø7	ø8
7 s	79 s	11 s	28 s

MADISON PIKE (KY 17) ROUNDABOUT FEASIBILITY STUDY
NKAPC
Fort Wright / Covington, Kentucky

APPENDIX C

MADISON PIKE (KY 17) ROUNDABOUT FEASIBILITY STUDY

Design Criteria

Designed By:

Date:

Checked By:

Date:

MADISON PIKE - SOUTH OF DUDLEY

For use with Old Madison Pike and Holds Branch Road Intersections

Item	Criteria	Reference
General - KYTC Standard Roadway Criteria		
Roadway Classification	Urban Arterial	KYTC Provided
Type of Terrain	Rolling	As-Builts
Design Speed	60 MPH	As-Builts, SP 059_35_15
Pavement Width	12' Lanes	KYTC Exhibit 700-04
Sidewalk	5' min., 8' des.	KYTC Exhibit 700-04
Design Vehicle	WB-62	KYTC Provided
Minimum Clear Zone	Varies - Fill, Cut, Foreslope, Traffic	AASHTO - RDG Table 3.1
Roundabout	Varies	FHWA/Ourston
Geometric Alignment		
Minimum Grade (curbed)	0.5% min	AASHTO pg 236
Minimum Grade (uncurbed)	Flat with adequate cross slope	AASHTO pg 236
Maximum Grade	6%	KYTC Exhibit 700-04
Stopping Sight Distance - 60 mph	SSD = 570 feet	KYTC Exhibit 700-04
Superelevation	4% - 6% max	KYTC Exhibit 700-04
Minimum Horizontal Radius - eMAX 4%	1500 feet	AASHTO Exhibit 3-15 pg 147
Normal Pavement Cross Slope	2%	KYTC Exhibit 700-04
Normal Shoulder Cross Slope	4% - paved, 8% - earth	KYTC Exhibit 700-04
Existing Mainline Typical Sections		
Existing Posted Speed	55 MPH	Observed
Lane Width	12' (Truck Route)	As-Builts, SP 059_35_15
Shoulder Width (Useable)	10 feet	As-Builts, SP 059_35_15
Shoulder Slope	4%	As-Builts, SP 059_35_15
Superelevation	2.6% max	As-Builts, SP 059_35_15
Fill Slope	4:1 under 10', 2:1 over 10'	As-Builts, SP 059_35_15
Foreslope	6:1	As-Builts, SP 059_35_15
Backslope	4:1 under 10', 2:1 over 10'	As-Builts, SP 059_35_15
Backslope (rock cut)	Approx. 1:1	Observed
Median	20' Mountable Median	As-Builts, SP 059_35_15

REFERENCES

AASHTO: A Policy on Geometric Design of Highways and Streets, 2004

AASHTO - RDG: Roadside Design Guide

As-Builts: Plans for KY 17 supplied by KYTC

KYTC: Kentucky Transportation Cabinet Highway Design Manual, 2006

FHWA/Ourston: FHWA-Roundabouts: An Informational Guide - FHWA-RD-00-067, 2000 / Ourston - Roundabout Design Guidelines

M:\proj\0631\0003\Report\Backup info\[Appendix C.xls]KY 17-NORTH

MADISON PIKE (KY 17) ROUNDABOUT FEASIBILITY STUDY

Design Criteria

Designed By:

Date:

Checked By:

Date:

MADISON PIKE - NORTH OF DUDLEY

For use with the TANK Facility Entrance and Brooks Dr. Intersection

Item	Criteria	Reference
General - KYTC Standard Roadway Criteria		
Roadway Classification	Urban Arterial	KYTC Provided
Type of Terrain	Rolling	As-Builts
Design Speed	50 MPH	As-Builts, SSP 059 0017 018-021
Pavement Width	12' Lanes	KYTC Exhibit 700-04
Sidewalk	5' min., 8' des.	KYTC Exhibit 700-04
Design Vehicle	WB-62	KYTC Provided
Minimum Clear Zone	Varies - Fill, Cut, Foreslope, Traffic	AASHTO - RDG Table 3.1
Roundabout	Varies	FHWA/Ourston
Geometric Alignment		
Minimum Grade (curbed)	0.5% min	AASHTO pg 236
Minimum Grade (uncurbed)	Flat with adequate cross slope	AASHTO pg 236
Maximum Grade	7%	KYTC Exhibit 700-04
Stopping Sight Distance - 50 mph	SSD = 425 feet	KYTC Exhibit 700-04
Superelevation	4% - 6% max	KYTC Exhibit 700-04
Minimum Horizontal Radius - eMAX 4%	926 feet	AASHTO Exhibit 3-15 pg 147
Normal Pavement Cross Slope	2%	KYTC Exhibit 700-04
Normal Shoulder Cross Slope	4% - paved, 8% - earth	KYTC Exhibit 700-04
Existing Mainline Typical Sections		
Existing Posted Speed	45 MPH	Observed
Lane Width	12' (Truck Route)	As-Builts, SSP 059 0017 018-021
Shoulder Width (Useable)	10 feet	As-Builts, SSP 059 0017 018-021
Shoulder Slope	4%	As-Builts, SSP 059 0017 018-021
Superelevation	2.6% max	As-Builts, SSP 059 0017 018-021
Fill Slope	4:1 under 10', 2:1 over 10'	As-Builts, SSP 059 0017 018-021
Foreslope	6:1	As-Builts, SSP 059 0017 018-021
Backslope	4:1 under 10', 2:1 over 10'	As-Builts, SSP 059 0017 018-021
Backslope (rock cut)	Approx. 1:1	Observed
Median	12' Transversable (flush)	Observed

REFERENCES

AASHTO: A Policy on Geometric Design of Highways and Streets, 2004

AASHTO - RDG: Roadside Design Guide

As-Builts: Plans for KY 17 supplied by KYTC

KYTC: Kentucky Transportation Cabinet Highway Design Manual, 2006

FHWA/Ourston: FHWA-Roundabouts: An Informational Guide - FHWA-RD-00-067, 2000 / Ourston - Roundabout Design Guidelines

M:\proj\0631\0003\Report\Backup info\[Appendix C.xls]KY 17-NORTH

MADISON PIKE (KY 17) ROUNDABOUT FEASIBILITY STUDY
NKAPC
Fort Wright / Covington, Kentucky

APPENDIX D

```

*****
*
* 7:7:06 KENTUCKY 17 KY 17/HOLDS BRANCH 194
*
*****
*
* E (m) 12.00 12.00 12.00 12.00 * TIME PERIOD min 90
* L' (m) 75.00 100.0 10.00 150.0 * TIME SLICE min 15
* V (m) 3.60 7.30 3.60 7.30 * RESULTS PERIOD min 15 75
* RAD (m) 27.00 27.00 27.00 27.00 * TIME COST $/hr 15.00
* PHI (d) 35.00 35.00 35.00 35.00 * FLOW PERIOD min 15 75
* DIA (m) 80.00 80.00 80.00 80.00 * FLOW TYPE pcu/veh VEH
* GRAD SEP 0 0 0 0 * FLOW PEAK am/op/pm AM
*
*****
* LEG NAME *PCU *FLOWS (1st exit 2nd etc...U) *FLOF*CL* FLOW RATIO *FLOW TIME*
* * * * * * * * * *
*BRANCH WB *1.06* 410 0 150 0 *1.00*50*0.95 1.050 0.95*15 45 75
*KY 17 SB *1.06* 0 1160 250 0 *1.00*50*0.95 1.050 0.95*15 45 75
*PARK EB *1.06* 0 0 0 0 *1.00*50*0.95 1.050 0.95*15 45 75
*KY 17 NB *1.06* 0 2990 0 0 *1.00*50*0.95 1.050 0.95*15 45 75
* * * * * * * * * *
* * * * * * * * * *
* * * * * * * * * *
*****
*
* FLOW veh 560 1410 0 2990
* CAPACITY veh 832 3131 921 3109 * AVDEL s 16.8
* AVE DELAY mins 0.21 0.03 0.00 0.41 * L O S C
* MAX DELAY mins 0.27 0.04 0.00 0.64 * VEH HRS 23.1
* AVE QUEUE veh 2 1 0 22 * COST $ 346.3
* MAX QUEUE veh 3 1 0 31
*
*****

```

```

*****
*
* 7:7:06                KENTUCKY 17 KY 17/HOLDS BRANCH                197
*
*****
*
* E      (m)    12.00  12.00  12.00  12.00      * TIME PERIOD    min    90
* L'     (m)    75.00  100.0  10.00  150.0      * TIME SLICE     min    15
* V      (m)     3.60   7.30   3.60   7.30      * RESULTS PERIOD min   15 75
* RAD    (m)    27.00  27.00  27.00  27.00      * TIME COST      $/hr  15.00
* PHI    (d)    35.00  35.00  35.00  35.00      * FLOW PERIOD    min   15 75
* DIA    (m)    80.00  80.00  80.00  80.00      * FLOW TYPE      pcu/veh  VEH
* GRAD SEP      0      0      0      0          * FLOW PEAK      am/op/pm  PM
*
*****
* LEG NAME *PCU *FLOWS (1st exit 2nd etc...U) *FLOF*CL* FLOW RATIO *FLOW TIME*
*          *   *
*BRANCH WB *1.06* 560  0  260  0          *1.00*50*0.95 1.050 0.95*15 45 75
*KY 17 SB  *1.06* 0  2520 380  0          *1.00*50*0.95 1.050 0.95*15 45 75
*PARK EB   *1.06* 10  5  10  0          *1.00*50*0.95 1.050 0.95*15 45 75
*KY 17 NB  *1.06* 0  1840 0  0          *1.00*50*0.95 1.050 0.95*15 45 75
*          *   *
*          *   *
*          *   *
*****
*
* FLOW          veh      820  2900  25  1840
* CAPACITY     veh     1572  3051  153  3003
* AVE DELAY    mins    0.08  0.35  0.46  0.05
* MAX DELAY    mins    0.09  0.52  0.64  0.06
* AVE QUEUE    veh      1    18    0    2
* MAX QUEUE    veh      1    25    0    2
*
*****

```

```

*****
*
* 7:7:06 KENTUCKY 17 KY 17/OLD KY 17 162
*
*****
*
* E (m) 12.00 8.40 4.50 * TIME PERIOD min 90
* L' (m) 100.0 25.00 10.00 * TIME SLICE min 15
* V (m) 7.30 3.60 4.50 * RESULTS PERIOD min 15 75
* RAD (m) 27.00 27.00 27.00 * TIME COST $/hr 15.00
* PHI (d) 35.00 35.00 35.00 * FLOW PERIOD min 15 75
* DIA (m) 75.00 75.00 75.00 * FLOW TYPE pcu/veh VEH
* GRAD SEP 0 0 0 * FLOW PEAK am/op/pm AM
*
*****
* LEG NAME *PCU *FLOWS (1st exit 2nd etc...U) *FLOF*CL* FLOW RATIO *FLOW TIME*
* * * * * * * * * *
*SB KY 17 *1.08* 150 1650 0 *1.00*50*0.95 1.050 0.95*15 45 75
*OLD 17 EB *1.08* 30 100 0 *1.00*50*0.95 1.050 0.95*15 45 75
*NB KY 17 *1.08* 0 30 0 *1.00*50*0.95 1.050 0.95*15 45 75
* * * * * * * * * *
* * * * * * * * * *
* * * * * * * * * *
* * * * * * * * * *
*****
*
* FLOW veh 1800 130 30
* CAPACITY veh 3157 965 1213 * AVDEL s 2.7
* AVE DELAY mins 0.04 0.07 0.05 * L O S A
* MAX DELAY mins 0.05 0.08 0.05 * VEH HRS 1.5
* AVE QUEUE veh 1 0 0 * COST $ 22.3
* MAX QUEUE veh 1 0 0
*
*****

```



```

*****
*
* 7:7:06 KENTUCKY 17 KY 17/OLD KY 17 163
*
*****
*
* E (m) 12.00 8.40 4.50 * TIME PERIOD min 90 *
* L' (m) 100.0 25.00 10.00 * TIME SLICE min 15 *
* V (m) 7.30 3.60 4.50 * RESULTS PERIOD min 15 75 *
* RAD (m) 27.00 27.00 27.00 * TIME COST $/hr 15.00 *
* PHI (d) 35.00 35.00 35.00 * FLOW PERIOD min 15 75 *
* DIA (m) 75.00 75.00 75.00 * FLOW TYPE pcu/veh VEH *
* GRAD SEP 0 0 0 * FLOW PEAK am/op/pm PM *
*
*****
* LEG NAME *PCU *FLOWS (1st exit 2nd etc...U) *FLOF*CL* FLOW RATIO *FLOW TIME*
* * * * * * * * * * *
*SB KY 17 *1.08* 170 2730 0 *1.00*50*0.95 1.050 0.95*15 45 75 *
*OLD 17 EB *1.08* 40 170 0 *1.00*50*0.95 1.050 0.95*15 45 75 *
*NB KY 17 *1.08* 0 40 0 *1.00*50*0.95 1.050 0.95*15 45 75 *
* * * * * * * * * * *
* * * * * * * * * * *
* * * * * * * * * * *
* * * * * * * * * * *
*****
*
* FLOW veh 2900 210 40 *
* CAPACITY veh 3149 396 1183 * AVDEL s 13.7 *
* AVE DELAY mins 0.22 0.32 0.05 * L O S B *
* MAX DELAY mins 0.31 0.41 0.06 * VEH HRS 12.0 *
* AVE QUEUE veh 11 1 0 * COST $ 180.0 *
* MAX QUEUE veh 15 1 0 *
*
*****

```

```

*****
*
* 7:7:06          KENTUCKY 17 KY 17/TANK/ELECTRIC/LAKEVIEW          129 *
*
*****
*
* E (m) 8.40 12.00 8.40 12.00 * TIME PERIOD min 90 *
* L' (m) 20.00 10.00 10.00 30.00 * TIME SLICE min 15 *
* V (m) 3.60 7.30 3.60 7.30 * RESULTS PERIOD min 15 75 *
* RAD (m) 20.00 20.00 20.00 20.00 * TIME COST $/hr 15.00 *
* PHI (d) 30.00 30.00 30.00 30.00 * FLOW PERIOD min 15 75 *
* DIA (m) 75.00 75.00 75.00 75.00 * FLOW TYPE pcu/veh VEH *
* GRAD SEP 0 0 0 0 * FLOW PEAK am/op/pm AM *
*
*****
* LEG NAME *PCU *FLOWS (1st exit 2nd etc...U)*FLOF*CL* FLOW RATIO *FLOW TIME*
* * * * * * * * * * * * * * * * * * * * * * * * * * * * * * * * * *
*TANK WB *1.08* 160 10 90 0 *1.00*50*0.95 1.050 0.95*15 45 75 *
*KY 17 SB *1.08* 60 980 150 0 *1.00*50*0.95 1.050 0.95*15 45 75 *
*NEW EB *1.08* 30 10 80 0 *1.00*50*0.95 1.050 0.95*15 45 75 *
*KY 17 NB *1.08* 240 1950 10 0 *1.00*50*0.95 1.050 0.95*15 45 75 *
* * * * * * * * * * * * * * * * * * * * * * * * * * * * * * * * * *
* * * * * * * * * * * * * * * * * * * * * * * * * * * * * * * * * *
* * * * * * * * * * * * * * * * * * * * * * * * * * * * * * * * * *
* * * * * * * * * * * * * * * * * * * * * * * * * * * * * * * * * *
* FLOW veh 260 1190 120 2200 * * * * * * * * * * * * * * * * * *
* CAPACITY veh 714 2503 954 2757 * AVDEL s 5.2 *
* AVE DELAY mins 0.13 0.05 0.07 0.10 * L O S A *
* MAX DELAY mins 0.15 0.05 0.08 0.12 * VEH HRS 5.4 *
* AVE QUEUE veh 1 1 0 4 * COST $ 81.7 *
* MAX QUEUE veh 1 1 0 4 * * * * * * * * * * * * * * * * * *
*
*****

```

```

*****
*
* 7:7:06          KENTUCKY 17 KY 17/TANK/ELECTRIC/LAKEVIEW          130
*
*****
*
* E      (m)      8.40  12.00  8.40  12.00          * TIME PERIOD      min      90
* L'     (m)      20.00  10.00  10.00  30.00         * TIME SLICE       min      15
* V      (m)      3.60   7.30   3.60   7.30          * RESULTS PERIOD   min     15 75
* RAD    (m)      20.00  20.00  20.00  20.00         * TIME COST        $/hr   15.00
* PHI    (d)      30.00  30.00  30.00  30.00         * FLOW PERIOD      min     15 75
* DIA    (m)      75.00  75.00  75.00  75.00         * FLOW TYPE        pcu/veh  VEH
* GRAD SEP      0      0      0      0              * FLOW PEAK        am/op/pm  PM
*
*****
* LEG NAME *PCU *FLOWS (1st exit 2nd etc...U) *FLOF*CL* FLOW RATIO *FLOW TIME*
*          *   *
*TANK WB   *1.08* 200  20  250  0          *1.00*50*0.95 1.050 0.95*15 45 75
*KY 17 SB  *1.08* 130 1600 170 0          *1.00*50*0.95 1.050 0.95*15 45 75
*NEW EB    *1.08* 30  20  110  0          *1.00*50*0.95 1.050 0.95*15 45 75
*KY 17 NB  *1.08* 320 1360 40  0          *1.00*50*0.95 1.050 0.95*15 45 75
*          *   *
*          *   *
*          *   *
*****
*
* FLOW      veh      470  1900  160  1720
* CAPACITY  veh      989  2373  570  2714          * AVDEL s      5.8
* AVE DELAY mins  0.11  0.12  0.14  0.06          * L O S      A
* MAX DELAY mins  0.13  0.15  0.16  0.07          * VEH HRS     6.9
* AVE QUEUE  veh      1      4      0      2          * COST $     103.0
* MAX QUEUE  veh      1      5      0      2
*
*****

```

MADISON PIKE (KY 17) ROUNDABOUT FEASIBILITY STUDY
NKAPC
Fort Wright / Covington, Kentucky

APPENDIX E

MADISON PIKE (KY 17) INTERSECTION IMPROVEMENTS STUDY

COST ESTIMATE SUMMARY

Madison Pike and Holds Branch Road / Pioneer Park

	Signalized	Roundabout
Construction Cost*	\$ 2,500,000	\$ 4,100,000
Right of Way Impacts ¹	0.6 acres	1.1 acres

¹ Does not include land required from Pioneer Park

Madison Pike and Old Madison Pike

	Signalized	Roundabout
Construction Cost*	\$ 5,800,000	\$ 5,000,000
Right of Way Impacts	1.7 acres ²	1.3 acres

² R/W required for east property access

Madison Pike and TANK Facility Entrance / Lakeview Drive

	Signalized	Roundabout
Construction Cost*	\$ 1,300,000	\$ 4,800,000
Right of Way Impacts	0.1 acres	1.6 acres

* All construction cost estimates rounded to the nearest \$100,000

CDS Associates, Inc.

Project: **MADISON AVE SIGNALIZED INTERSECTIONS
PRELIMINARY OPINION OF CONSTRUCTION COST**

Date: 07/28/2006
Project No.: 2005882

ITEM NO.	SPEC. NO.	ITEM	Estimated Quantity	Unit of Measure	Unit Cost Total	Total Amount Bid
		KY 17 & HOLDS BRANCH - 2150 LF				
		CLEARING AND GRUBBING	1	LS	\$4,000.00	\$4,000.00
		PAVEMENT MILLING	18200	SY	\$2.75	\$50,050.00
		EMBANKMENT (11525 SY x 5')	15000	CY	\$15.00	\$225,000.00
		EXCAVATION (INCLUDES REMOVAL OF PAVEMENT)	3120	CY	\$14.00	\$43,680.00
		3" ASPHALT SURFACE (Area = 18200 SY)	3035	TN	\$62.00	\$188,170.00
		8" AGGREGATE BASE (Area = 4725 SY)	2100	TN	\$22.00	\$46,200.00
		15" ASPHALT PAVEMENT (Area = 4725 SY) - (Shoulder Area = 6800)	9610	TN	\$62.00	\$595,820.00
		CURB AND GUTTER	3000	LF	\$25.00	\$75,000.00
		TRAFFIC SIGNAL	1	LS	\$85,000.00	\$85,000.00
		LIGHTING	1	LS	\$35,000.00	\$35,000.00
		WATERMAIN REPLACEMENT	1000	LF	\$80.00	\$80,000.00
		SIGNING/PAVEMENT MARKING	1	LS	\$50,000.00	\$50,000.00
		RESTORATION (SEED AND MULCH)	4780	SY	\$2.50	\$11,950.00
		MAINTENANCE OF TRAFFIC	1	LS	\$20,000.00	\$20,000.00
		MISC ITEMS (15%)	1	LS	\$226,480.50	\$226,480.50
		SUBTOTAL				\$1,736,350.50
		CONTINGENCY (20%) ±				\$347,270.10
		CONSTRUCTION TOTAL				\$2,083,620.60
		USE ESTIMATED CONSTRUCTION TOTAL				\$2,100,000.00
		ENGINEERING FEES (20%)				\$420,000.00
		USE ENGINEERING FEES				\$400,000.00
		TOTAL				\$2,500,000.00

Note: Driveway work, ROW acquisition costs, landscaping and utility costs other than water main relocation are not included in the above figures.

CDS Associates, Inc.

Project: **MADISON AVE ROUNDABOUT STUDY
PRELIMINARY OPINION OF CONSTRUCTION COST**

Date: 07/28/2006
Project No.: 2005882

ITEM NO.	SPEC. NO.	ITEM	Estimated Quantity	Unit of Measure	Unit Cost Total	Total Amount Bid	
		KY 17 & HOLDS BRANCH					
		CLEARING AND GRUBBING	1	LS	\$5,000.00	\$5,000.00	
		PAVEMENT REMOVAL	9360	SY	\$10.00	\$93,600.00	
		RETAINING WALL (400' x 10')	4000	SF	\$85.00	\$340,000.00	
		EMBANKMENT	20000	CY	\$15.00	\$300,000.00	
		8" AGGREGATE BASE	6100	TN	\$22.00	\$134,200.00	
		15" ASPHALT PAVEMENT	11300	TN	\$62.00	\$700,600.00	
		20' BOX CULVERT - 50 LF EXTENSION WITH HEADWALL	1	LS	\$250,000.00	\$250,000.00	
		CHANNEL REGRADING	120	LF	\$125.00	\$15,000.00	
		STORM PIPE	2500	LF	\$60.00	\$150,000.00	
		STORM STRUCTURES	20	EA	\$2,500.00	\$50,000.00	
		CONCRETE APRON	690	SY	\$65.00	\$44,850.00	
		CURB AND GUTTER	2500	LF	\$25.00	\$62,500.00	
		LIGHTING	1	LS	\$80,000.00	\$80,000.00	
		WATERMAIN REPLACEMENT	1500	LF	\$80.00	\$120,000.00	
		SIGNING/PAVEMENT MARKING (incl. warning signs with lights)	1	LS	\$50,000.00	\$50,000.00	
		RESTORATION (SEED AND MULCH)	2800	SY	\$2.50	\$7,000.00	
		MAINTENANCE OF TRAFFIC	1	LS	\$40,000.00	\$40,000.00	
		MISC ITEMS (15%)	1	LS	\$366,412.50	\$366,412.50	
		SUBTOTAL					\$2,809,162.50
		CONTINGENCY (20%) ±					\$561,832.50
		CONSTRUCTION TOTAL					\$3,370,995.00
		USE ESTIMATED CONSTRUCTION TOTAL					\$3,400,000.00
		ENGINEERING FEES (20%)					\$680,000.00
		USE ENGINEERING FEES					\$700,000.00
		TOTAL					\$4,100,000.00

Note: Driveway work, ROW acquisition costs, landscaping and utility costs other than water main relocation are not included in the above figures.

CDS Associates, Inc.

Project:

**MADISON AVE SIGNALIZED INTERSECTIONS
PRELIMINARY OPINION OF CONSTRUCTION COST**

Date: 07/28/2006
Project No.: 2005882

ITEM NO.	SPEC. NO.	ITEM	Estimated Quantity	Unit of Measure	Unit Cost Total	Total Amount Bid
		KY 17 & OLD KY 17				
		CLEARING AND GRUBBING	1	LS	\$5,000.00	\$5,000.00
		PAVEMENT MILLING	16550	SY	\$2.75	\$45,512.50
		BANK LICK CREEK BRIDGE DECK WIDENING	11000	SF	\$185.00	\$2,035,000.00
		EMBANKMENT	15000	CY	\$15.00	\$225,000.00
		EXCAVATION (Includes removal of existing pavement)	3000	CY	\$14.00	\$42,000.00
		3" ASPHALT SURFACE (Area = 16550 SY)	2760	TN	\$62.00	\$171,120.00
		8" AGGREGATE BASE (Area = 3630 SY)	1620	TN	\$22.00	\$35,640.00
		15" ASPHALT PAVEMENT (Area = 3630 SY) - (Shoulder Area = 6800)	9050	TN	\$62.00	\$561,100.00
		CURB AND GUTTER	2470	LF	\$25.00	\$61,750.00
		TRAFFIC SIGNAL	1	LS	\$85,000.00	\$85,000.00
		LIGHTING	1	LS	\$35,000.00	\$35,000.00
		WATERMAIN REPLACEMENT	800	LF	\$80.00	\$64,000.00
		SIGNING/PAVEMENT MARKING/SIGNING	1	LS	\$50,000.00	\$50,000.00
		RESTORATION (SEED AND MULCH)	4200	SY	\$2.50	\$10,500.00
		MAINTENANCE OF TRAFFIC	1	LS	\$17,000.00	\$17,000.00
		MISC ITEMS (15%)	1	LS	\$516,543.38	\$516,543.38
		SUBTOTAL				\$3,960,165.88
		CONTINGENCY (20%) ±				\$792,033.18
		CONSTRUCTION TOTAL				\$4,752,199.05
		USE ESTIMATED CONSTRUCTION TOTAL				\$4,800,000.00
		ENGINEERING FEES (20%)				\$960,000.00
		USE ENGINEERING FEE				\$1,000,000.00
		TOTAL				\$5,800,000.00

Note: Driveway work, ROW acquisition costs, landscaping and utility costs other than water main relocation are not included in the above figures. Work on the Bank Lick Creek Bridge will consist of widening, resurfacing and pavement marking.

CDS Associates, Inc.

Project: **MADISON AVE ROUNDABOUT STUDY
PRELIMINARY OPINION OF CONSTRUCTION COST**

Date: 07/28/2006
Project No.: 2005882

ITEM NO.	SPEC. NO.	ITEM	Estimated Quantity	Unit of Measure	Unit Cost Total	Total Amount Bid
		KY 17 & OLD KY 17				
		CLEARING AND GRUBBING	1	LS	\$6,000.00	\$6,000.00
		PAVEMENT REMOVAL	8360	SY	\$10.00	\$83,600.00
		RETAINING WALL (515' X 15')	7725	SF	\$95.00	\$733,875.00
		EMBANKMENT	18000	CY	\$15.00	\$270,000.00
		EXCAVATION	9000	CY	\$14.00	\$126,000.00
		8" AGGREGATE BASE	7700	TN	\$22.00	\$169,400.00
		15" ASPHALT PAVEMENT	14400	TN	\$62.00	\$892,800.00
		STORM PIPE	1800	LF	\$60.00	\$108,000.00
		STORM STRUCTURES	11	EA	\$2,500.00	\$27,500.00
		CONCRETE APRON	610	SY	\$65.00	\$39,650.00
		CURB AND GUTTER	3700	LF	\$25.00	\$92,500.00
		CONCRETE MEDIAN - 10' WIDE	665	LF	\$70.00	\$46,550.00
		LIGHTING	1	LS	\$80,000.00	\$80,000.00
		WATERMAIN REPLACEMENT	2000	LF	\$80.00	\$160,000.00
		SIGNING/PAVEMENT MARKING (incl. warning signs with lights)	1	LS	\$50,000.00	\$50,000.00
		RESTORATION (SEED AND MULCH)	2700	SY	\$2.50	\$6,750.00
		MAINTENANCE OF TRAFFIC	1	LS	\$45,000.00	\$45,000.00
		MISC ITEMS (15%)	1	LS	\$440,643.75	\$440,643.75
		SUBTOTAL				\$3,378,268.75
		CONTINGENCY (20%) ±				\$844,567.19
		CONSTRUCTION TOTAL				\$4,222,835.94
		USE ESTIMATED CONSTRUCTION TOTAL				\$4,200,000.00
		ENGINEERING FEES (20%)				\$840,000.00
		USE ENGINEERING FEES				\$800,000.00
		TOTAL				\$5,000,000.00

Note: Driveway work, ROW acquisition costs, landscaping and utility costs other than water main relocation are not included in the above figures. Work on the Bank Lick Creek Bridge will consist only of resurfacing and pavement marking.

CDS Associates, Inc.

Project: **MADISON AVE SIGNALIZED INTERSECTIONS
PRELIMINARY OPINION OF CONSTRUCTION COST**

Date: 07/28/2006
Project No.: 2005882

ITEM NO.	SPEC. NO.	ITEM	Estimated Quantity	Unit of Measure	Unit Cost Total	Total Amount Bid	
		KY 17 & TANK ENTRANCE 950 LF					
		CLEARING AND GRUBBING	1	LS	\$5,000.00	\$5,000.00	
		PAVEMENT MILLING	8310	SY	\$2.75	\$22,852.50	
		RETAINING WALL (250' X 5.5')	1400	SF	\$95.00	\$133,000.00	
		EXCAVATION (Includes removal of existing pavement)	6000	CY	\$14.00	\$84,000.00	
		3" ASPHALT SURFACE (Area = 8310 SY)	695	TN	\$62.00	\$43,090.00	
		8" AGGREGATE BASE (Area = 1338 SY)	600	TN	\$22.00	\$13,200.00	
		15" ASPHALT PAVEMENT (Area = 1338 SY) - (Shoulder Area = 3780)	4300	TN	\$62.00	\$266,600.00	
		CURB AND GUTTER	450	LF	\$25.00	\$11,250.00	
		TRAFFIC SIGNAL	1	LS	\$93,000.00	\$93,000.00	
		LIGHTING	1	LS	\$35,000.00	\$35,000.00	
		WATERMAIN REPLACEMENT	350	LF	\$80.00	\$28,000.00	
		SIGNING/PAVEMENT MARKING	1	LS	\$50,000.00	\$50,000.00	
		RESTORATION (SEED AND MULCH)	2500	SY	\$2.50	\$6,250.00	
		MAINTENANCE OF TRAFFIC	1	LS	\$25,000.00	\$25,000.00	
		MISC ITEMS (15%)	1	LS	\$122,436.38	\$122,436.38	
		SUBTOTAL					\$938,678.88
		CONTINGENCY (20%) ±					\$187,735.78
		CONSTRUCTION TOTAL					\$1,126,414.65
		USE ESTIMATED CONSTRUCTION TOTAL					\$1,100,000.00
		ENGINEERING FEES (20%)					\$220,000.00
		USE ENGINEERING FEES					\$200,000.00
		TOTAL					\$1,300,000.00

Note: Driveway work, ROW acquisition costs, landscaping and utility costs other than water main relocation are not included in the above figures.

CDS Associates, Inc.

Project:

**MADISON AVE ROUNDABOUT STUDY
PRELIMINARY OPINION OF CONSTRUCTION COST**

Date: 07/28/2006
Project No.: 2005882

ITEM NO.	SPEC. NO.	ITEM	Estimated Quantity	Unit of Measure	Unit Cost Total	Total Amount Bid	
		KY 17 & TANK ENTRANCE					
		CLEARING AND GRUBBING	1	LS	\$20,000.00	\$20,000.00	
		PAVEMENT REMOVAL	9670	SY	\$10.00	\$96,700.00	
		RETAINING WALL	7940	SF	\$100.00	\$794,000.00	
		EMBANKMENT	2000	CY	\$15.00	\$30,000.00	
		EXCAVATION - SOIL AND ROCK	20000	CY	\$25.00	\$500,000.00	
		8" AGGREGATE BASE	5120	TN	\$22.00	\$112,640.00	
		15" ASPHALT PAVEMENT	9600	TN	\$62.00	\$595,200.00	
		LAKEVIEW TO BROOKS LANE CONNECTOR ROAD (Includes Cul de sac)	1	LS	\$50,000.00	\$50,000.00	
		STORM PIPE	4100	LF	\$60.00	\$246,000.00	
		STORM STRUCTURES	18	EA	\$2,500.00	\$45,000.00	
		CONCRETE APRON	610	SY	\$65.00	\$39,650.00	
		CURB AND GUTTER	2300	LF	\$25.00	\$57,500.00	
		LIGHTING	1	LS	\$85,000.00	\$85,000.00	
		WATERMAIN REPLACEMENT	1000	LF	\$80.00	\$80,000.00	
		SIGNING/PAVEMENT MARKING (incl. warning signs with lights)	1	LS	\$50,000.00	\$50,000.00	
		RESTORATION (SEED AND MULCH)	2500	SY	\$2.50	\$6,250.00	
		RELOCATE TANK SIGN	1	LS	\$8,000.00	\$8,000.00	
		MAINTENANCE OF TRAFFIC	1	LS	\$60,000.00	\$60,000.00	
		MISC ITEMS (15%)	1	LS	\$431,391.00	\$431,391.00	
		SUBTOTAL					\$3,307,331.00
		CONTINGENCY (20%) ±					\$661,466.20
		CONSTRUCTION TOTAL					\$3,968,797.20
		USE ESTIMATED CONSTRUCTION TOTAL					\$4,000,000.00
		ENGINEERING FEES (20%)					\$800,000.00
		USE ENGINEERING FEES					\$800,000.00
		TOTAL					\$4,800,000.00

Note: Driveway work, ROW acquisition costs, landscaping and utility costs other than water main relocation are not included in the above figures.